



4D SYSTEMS
TURNING TECHNOLOGY INTO ART

PICASO
Internal 4DGL Functions

REFERENCE

Document Date: 12th January 2013
Document Revision: 6.3

Contents

1. 4DGL Introduction	8
2. PICASO Chip-Resident Functions Summary	9
2.1. GPIO Functions.....	15
2.1.1. pin_Set(mode, pin).....	16
2.1.2. pin_HI(pin).....	17
2.1.3. pin_LO(pin).....	18
2.1.4. pin_Read(pin).....	19
2.1.5. bus_In().....	20
2.1.6. bus_Out(arg).....	21
2.1.7. bus_Set(arg).....	22
2.1.8. bus_Write(data).....	23
2.1.9. bus_Read().....	24
2.2. System Memory Access Functions.....	25
2.2.1. peekW(address).....	26
2.2.2. pokeW(address, word_value).....	27
2.3. Maths Functions.....	28
2.3.1. ABS(value).....	29
2.3.2. MIN(value1, value2).....	30
2.3.3. MAX(value1, value2).....	31
2.3.4. SWAP(&var1, &var2).....	32
2.3.5. SIN(angle).....	33
2.3.6. COS(angle).....	34
2.3.7. RAND().....	35
2.3.8. SEED(number).....	36
2.3.9. SQRT(number).....	37
2.3.10. OVF().....	38
2.3.11. CY().....	39
2.3.12. umul_1616(&res32, val1, val2).....	40
2.3.13. uadd_3232(&res32, &val1, &val2).....	41
2.3.14. usub_3232(&res32, &val1, &val2).....	42
2.3.15. ucmp_3232(&val1, &val2).....	43
2.4. Text and String Functions.....	44
2.4.1. txt_MoveCursor(line, column).....	45
2.4.2. putch(char).....	46
2.4.3._putstr(pointer).....	47
2.4.4. putnum(format, value).....	49
2.4.5. print(...).....	51
2.4.6. to(outstream).....	53
2.4.7. charwidth('char').....	55
2.4.8. charheight('char').....	56
2.4.9. strwidth(pointer).....	57
2.4.10. strheight().....	58
2.4.11. strlen(pointer).....	59
2.4.12. txt_Set(function, value).....	60

2.5. Ctype Functions.....	62
2.5.1. isdigit(char).....	63
2.5.2. isxdigit(char).....	64
2.5.3. isupper(char).....	65
2.5.4. islower(char).....	66
2.5.5. isalpha(char).....	67
2.5.6. isalnum(char).....	68
2.5.7. isprint(char).....	69
2.5.8. isspace(char).....	70
2.5.9. toupper(char).....	71
2.5.10. tolower(char).....	72
2.5.11. LByte(var).....	73
2.5.12. HByte(var).....	74
2.5.13. ByteSwap(var).....	75
2.6. Graphics Functions.....	76
2.6.1. gfx_Cls().....	78
2.6.2. gfx_ChangeColour(oldColour, newColour).....	79
2.6.3. gfx_Circle(x, y, radius, colour).....	80
2.6.4. gfx_CircleFilled(x, y, radius, colour).....	81
2.6.5. gfx_Line(x1, y1, x2, y2, colour).....	82
2.6.6. gfx_Hline(y, x1, x2, colour).....	83
2.6.7. gfx_Vline(x, y1, y2, colour).....	84
2.6.8. gfx_Rectangle(x1, y1, x2, y2, colour).....	85
2.6.9. gfx_RectangleFilled(x1, y1, x2, y2, colour).....	86
2.6.10. gfx_Polyline(n, vx, vy, colour).....	87
2.6.11. gfx_Polygon(n, vx, vy, colour).....	89
2.6.12. gfx_Triangle(x1, y1, x2, y2, x3, y3, colour).....	90
2.6.13. gfx_Dot().....	91
2.6.14. gfx_Bullet(radius).....	92
2.6.15. gfx_OrbitInit(&x_dest, &y_dest).....	93
2.6.16. gfx_Orbit(angle, distance).....	94
2.6.17. gfx_PutPixel(x, y, colour).....	95
2.6.18. gfx_GetPixel(x, y).....	96
2.6.19. gfx_MoveTo(xpos, ypos).....	97
2.6.20. gfx_MoveRel(xoffset, yoffset).....	98
2.6.21. gfx_IncX().....	99
2.6.22. gfx_IncY().....	100
2.6.23. gfx_LineTo(xpos, ypos).....	101
2.6.24. gfx_LineRel(xpos, ypos).....	102
2.6.25. gfx_BoxTo(x2, y2).....	103
2.6.26. gfx_SetClipRegion().....	104
2.6.27. gfx_Ellipse(x, y, xrad, yrad, colour).....	105
2.6.28. gfx_EllipseFilled(x, y, xrad, yrad, colour).....	106
2.6.29. gfx_Button(state, x, y, buttonColour, txtColour, font, txtWidth txtHeight, text).....	107
2.6.30. gfx_Panel(state, x, y, Width, Height, Colour).....	109
2.6.31. gfx_Slider(mode, x1, y1, x2, y2, colour, scale, value).....	110
2.6.32. gfx_ScreenCopyPaste(xs, ys, xd, yd, width, height).....	111
2.6.33. gfx_RGBto565(RED, GREEN, BLUE).....	112
2.6.34. gfx_332to565(COLOUR).....	113
2.6.35. gfx_Selection(index, backColour, textColour).....	114
2.6.36. gfx_TriangleFilled(x1, y1, x2, y2, x3, y3, colour).....	115

2.6.37. gfx_PolygonFilled(n, vx, vy, colour)	116
2.6.38. gfx_Origin(x, y)	117
2.6.39. gfx_Get(mode)	118
2.6.40. gfx_ClipWindow(x1, y1, x2, y2)	119
2.6.41. gfx_Set(function, value)	120
2.7. Display I/O Functions	123
2.7.1. disp_SetReg(register, data)	124
2.7.2. disp_setGRAM(x1, y1, x2, y2)	125
2.7.3. disp_WrGRAM(colour)	126
2.7.4. disp_WriteControl(value)	127
2.7.5. disp_WriteWord(value)	128
2.7.6. disp_ReadWord(value)	129
2.7.7. disp_Sync(line)	130
2.8. Media Functions (SD/SDHC Memory Card or Serial Flash chip)	131
2.8.1. media_Init()	132
2.8.2. media_SetAdd(HIword, LOword)	133
2.8.3. media_SetSector(HIword, LOword)	134
2.8.4. media_RdSector(Destination_Address)	135
2.8.5. media_WrSector(Source_Address)	136
2.8.6. media_ReadByte()	137
2.8.7. media_ReadWord()	138
2.8.8. media_WriteByte(byte_val)	139
2.8.9. media_WriteWord(word_val)	140
2.8.10. media_Flush()	141
2.8.11. media_Image(x, y)	142
2.8.12. media_Video(x, y)	143
2.8.13. media_VideoFrame(x, y, frameNumber)	144
2.9. Flash Memory Chip Functions	146
2.9.1. flash_SIG()	147
2.9.2. flash_ID()	148
2.9.3. flash_BulkErase()	149
2.9.4. flash_BlockErase(blockAddress)	150
2.10. SPI Control Functions	151
2.10.1. spi_Init(speed, input_mode, output_mode)	152
2.10.2. spi_Read()	153
2.10.3. spi_Write(byte)	154
2.10.4. spi_Disable()	155
2.11. Serial (UART) Communications Functions	156
2.11.1. setbaud(rate)	157
2.11.2. com_SetBaud(comport, baudrate/10)	158
2.11.3. serin()	159
2.11.4. serout(char)	160
2.11.5. com_Init(buffer, bufsize, qualifier)	161
2.11.6. com_Reset()	163
2.11.7. com_Count()	164
2.11.8. com_Full()	165
2.11.9. com_Error()	166
2.11.10. com_Sync()	167
2.11.11. com_TXbuffer(buf, bufsize, pin)	168
2.11.12. com_TXbufferHold(state)	169

2.11.13. com_TXcount()	170
2.11.14. com_TXemptyEvent(function)	171
2.12. I2C BUS Master Functions	173
2.12.1. I2C_Open(Speed)	174
2.12.2. I2C_Close()	175
2.12.3. I2C_Start	176
2.12.4. I2C_Stop	177
2.12.5. I2C_Restart()	178
2.12.6. I2C_Read	179
2.12.7. I2C_Write(byte)	180
2.12.8. I2C_Ack	181
2.12.9. I2C_Nack()	182
2.12.10. I2C_AckStatus	183
2.12.11. I2C_AckPoll(control)	184
2.12.12. I2C_Idle()	185
2.12.13. I2C_Gets(buffer, size)	186
2.12.14. I2C_Getn	187
2.12.15. I2C_Puts(buffer)	188
2.12.16. I2C_Putn	189
2.13. Timer Functions	190
2.13.1. sys_T()	191
2.13.2. sys_T_HI()	192
2.13.3. sys_SetTimer(timernum, value)	193
2.13.4. sys_GetTimer(timernum)	194
2.13.5. sys_SetTimerEvent(timernum, function)	195
2.13.6. sys_EventQueue()	196
2.13.7. sys_EventsPostpone()	197
2.13.8. sys_EventsResume()	198
2.13.9. sys_Sleep(units)	199
2.13.10. iterator(offset)	200
2.14. FAT16 File Functions	201
2.14.1. file_Error()	202
2.14.2. file_Count(filename)	203
2.14.3. file_Dir(filename)	204
2.14.4. file_FindFirst(fname)	205
2.14.5. file_FindNext()	206
2.14.6. file_Exists(fname)	207
2.14.7. file_Open(fname, mode)	208
2.14.8. file_Close(handle)	209
2.14.9. file_Read(destination, size, handle)	210
2.14.10. file_Seek(handle, HiWord, LoWord)	211
2.14.11. file_Index(handle, Hisize, LoSize, recordnum)	212
2.14.12. file_Tell(handle, &HiWord, &LoWord)	213
2.14.13. file_Write(*source, size, handle)	214
2.14.14. file_Size(handle, &HiWord, &LoWord)	215
2.14.15. file_Image(x, y, handle)	216
2.14.16. file_ScreenCapture(x, y, width, height, handle)	217
2.14.17. file_PutC(char, handle)	218
2.14.18. file_GetC(handle)	219
2.14.19. file_PutW(word, handle)	220

2.14.20. file_GetW(handle)	221
2.14.21. file_PutS(*source, handle)	222
2.14.22. file_GetS(*string, size, handle).....	223
2.14.23. file_Erase(fname)	224
2.14.24. file_Rewind(handle)	225
2.14.25. file_LoadFunction(fname.4XE)	226
2.14.26. file_Run(fname.4XE, arglistptr)	228
2.14.27. file_Exec(fname.4XE, arglistptr)	233
2.14.28. file_LoadImageControl(fname1, fname2, mode).....	234
2.14.29. file_Mount()	237
2.14.30. file_Unmount().....	238
2.14.31. file_PlayWAV(fname)	239
2.15. Sound Control Functions	240
2.15.1. Snd_Volume(var).....	241
2.15.2. Snd_Pitch(pitch)	242
2.15.3. Snd_BufSize(var).....	243
2.15.4. snd_Stop()	244
2.15.5. snd_Pause()	245
2.15.6. snd_Continue()	246
2.15.7. snd_Playing()	247
2.16. String Class Functions.....	248
2.16.1. str_Ptr(&var).....	249
2.16.2. str_GetD(&ptr, &var).....	250
2.16.3. str_GetW(&ptr, &var).....	251
2.16.4. str_GetHexW(&ptr, &var)	252
2.16.5. str_GetC(&ptr, &var).....	253
2.16.6. str_GetByte(ptr)	254
2.16.7. str_GetWord(ptr)	255
2.16.8. str_PutByte(ptr, val)	256
2.16.9. str_PutWord(ptr, val)	257
2.16.10. str_Match(&ptr, *str)	258
2.16.11. str_MatchI(&ptr, *str)	259
2.16.12. str_Find(&ptr, *str).....	260
2.16.13. str_FindI(&ptr, *str).....	261
2.16.14. str_Length(ptr)	262
2.16.15. str_Printf(&ptr, *format).....	263
2.16.16. str_Cat(&destination, &source)	265
2.16.17. str_CatN(&ptr, str, count)	266
2.16.18. str_ByteMove(src, dest, count).....	267
2.16.19. str_Copy(dest, src).....	268
2.16.20. str_CopyN(dest, src, count).....	269
2.17. Touch Screen Functions	270
2.17.1. touch_DetectRegion(x1, y1, x2, y2)	271
2.17.2. touch_Set(mode).....	272
2.17.3. touch_Get(mode)	273
2.18. Image Control Functions	274
2.18.1. img_SetPosition(handle, index, xpos, ypos).....	275
2.18.2. img_Enable(handle, index).....	276
2.18.3. img_Disable(handle, index).....	277
2.18.4. img_Darken(handle, index)	278

2.18.5. img_Lighten(handle, index).....	279
2.18.6. img_SetWord(handle, index, offset, word).....	280
2.18.7. img_GetWord(handle, index, offset).....	281
2.18.8. img_Show(handle, index).....	283
2.18.9. img_SetAttributes(handle, index, value).....	284
2.18.10. img_ClearAttributes(handle, index, value).....	285
2.18.11. img_Touched(handle, index).....	286
2.19. Memory Allocation Functions	287
2.19.1. mem_Alloc(size)	288
2.19.2. mem_Allocv(size)	289
2.19.3. mem_Allocz(size).....	290
2.19.4. mem_Realloc(&ptr, size).....	291
2.19.5. mem_Free(allocation)	292
2.19.6. mem_Heap().....	293
2.19.7. mem_Set(ptr, char, size)	294
2.19.8. mem_Copy(source, destination, count).....	296
2.19.9. mem_Compare(ptr1, ptr2, count).....	297
2.20. General Purpose Functions	298
2.20.1. pause(time)	299
2.20.2. lookup8(key, byteConstList)	300
2.20.3. lookup16(key, wordConstList).....	301
3. PICASO EVE System Registers Memory Map	302
4. Appendix A : Example 4DGL Code.....	305
5. Appendix B : Runtime Error Messages	311
6. Hardware Tools	312
6.1. 4D Programming Cable	312
6.2. Evaluation Display Modules	312
7. 4D Systems - Workshop 4 IDE.....	312
7.1. Workshop 4 – Designer Environment	312
7.2. Workshop 4 – ViSi Environment.....	313
7.3. Workshop 4 – ViSi Genie Environment	313
7.4. Workshop 4 – Serial Environment.....	313
8. Revision History.....	315
9. Legal Notice.....	317
10. Contact Information.....	317

1. 4DGL Introduction

The 4D-Labs family of embedded graphics processors (GOLDELOX and PICASO) are powered by a highly optimised soft core virtual engine, E.V.E. (Extensible Virtual Engine).

EVE is a proprietary, high performance virtual processor with an extensive byte-code instruction set optimised to execute compiled 4DGL programs. 4DGL (4D Graphics Language) was specifically developed from ground up for the EVE engine core. It is a high level language which is easy to learn and simple to understand yet powerful enough to tackle many embedded graphics applications.

4DGL is a graphics oriented language allowing rapid application development. An extensive library of graphics, text and file system functions and the ease of use of a language that combines the best elements and syntax structure of languages such as C, Basic, Pascal, etc. Programmers familiar with these languages will feel right at home with 4DGL. It includes many familiar instructions such as IF..ELSE..ENDIF, WHILE..WEND, REPEAT..UNTIL, GOSUB..ENDSUB, GOTO as well as a wealth of (chip-resident) internal functions that include SERIN, SEROUT, GFX_LINE, GFX_CIRCLE and many more.

This document covers the internal (chip-resident) functions available for the PICASO Processor. This document should be used in conjunction with **"4DGL-Programmers-Reference-Manual"** document.

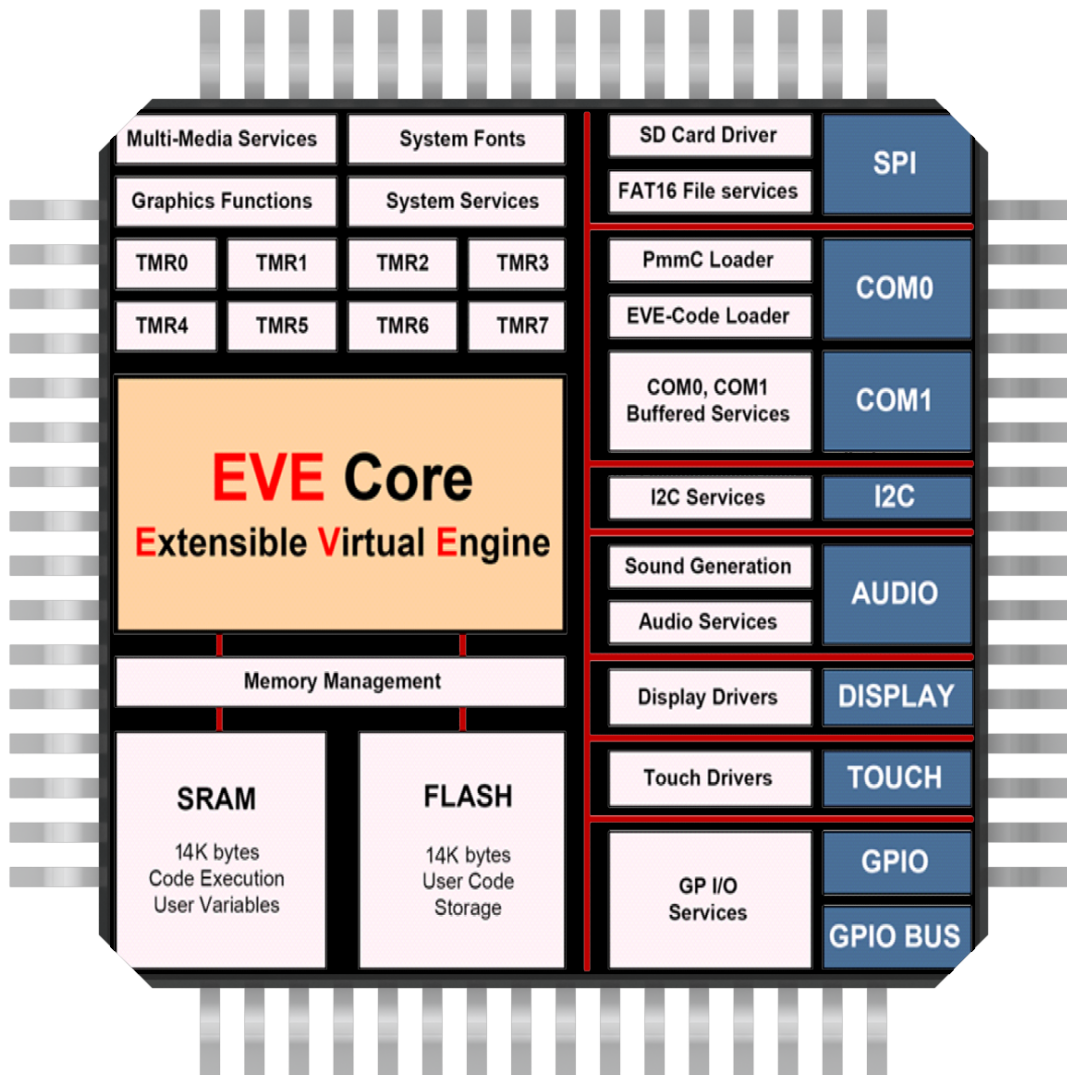

PICASO Internal Block Diagram

2. PICASO Chip-Resident Functions Summary

The following is a summary of chip-resident 4DGL functions within the PICASO graphics processor. The document is made up of the following sections:

2.1 GPIO Functions:

- pin_Set(mode, pin)
 - OUTPUT, INPUT
- pin_HI(pin)
- pin_LO(pin)
- pin_Read(pin)
- bus_In()
- bus_Out("var")
- bus_Set("var")
- bus_Write("var")
- bus_Read("var")

2.2 System Memory Access Functions:

- peekW(address)
- pokeW(address, word_value)

2.3 Maths Functions:

- ABS(value)
- MIN(value1, value2)
- MAX(value1, value2)
- SWAP(&var1, &var2)
- SIN(angle)
- COS(angle)
- RAND()
- SEED(number)
- SQRT(number)
- OVF ()
- CY()
- umul_1616(&res32, val1, val2)
- uadd_3232(&res32, &val1, &val2)
- usub_3232(&res32, &val1, &val2)
- ucmp_3232(&val1, &val2)

2.4 Text and String Functions:

- txt_MoveCursor(line, column)
- putch(char)
- putstr(pointer)
- putnum(format, value)
- print(...)
- to(outstream)
- charwidth('char')
- charheight('char')
- strwidth(pointer)
- strheight()
- strlen(pointer)
- txt_Set(function, value)
- **txt_Set shortcuts:**
 - txt_FGcolour(colour)
 - txt_BGcolour(colour)
 - txt_FontID(id)

- txt_Width(multiplier)
- txt_Height(multiplier)
- txt_Xgap(pixelcount)
- txt_Ygap(pixelcount)
- txt_Delay(millisecs) [deprecated]
- txt_Opacity(mode)
- txt_Bold(mode)
- txt_Italic(mode)
- txt_Inverse(mode)
- txt_Underlined(mode)
- txt_Attributes(value)
- txt_Wrap(value)

2.5 CType Functions:

- isdigit(char)
- isxdigit(char)
- isupper(char)
- islower(char)
- isalpha(char)
- isalnum(char)
- isprint(char)
- isspace(char)
- iswhite(char)
- toupper(char)
- tolower(char)
- LObyte(var)
- HIbyte(var)
- ByteSwap(var)

2.6 Graphics Functions:

- gfx_Cls()
- gfx_ChangeColour(oldColour, newColour)
- gfx_Circle(x, y, radius, colour)
- gfx_CircleFilled(x, y, radius, colour)
- gfx_Line(x1, y1, x2, y2, colour)
- gfx_Hline(y, x1, x2, colour)
- gfx_Vline(x, y1, y2, colour)
- gfx_Rectangle(x1, y1, x2, y2, colour)
- gfx_RectangleFilled(x1, y1, x2, y2, colour)
- gfx_Polyline(n, vx, vy, colour)
- gfx_Polygon(n, vx, vy, colour)
- gfx_Triangle(x1, y1, x2, y2, x3, y3, colour)
- gfx_Dot()
- gfx_Bullet(radius)
- gfx_OrbitInit(&x_dest, &y_dest)
- gfx_Orbit(angle, distance)
- gfx_PutPixel(x, y, colour)
- gfx_GetPixel(x, y)
- gfx_MoveTo(xpos, ypos)
- gfx_MoveRel(xoffset, yoffset)
- gfx_IncX()
- gfx_IncY()
- gfx_LineTo(xpos, ypos)
- gfx_LineRel(xpos, ypos)

- gfx_BoxTo(x2, y2)
- gfx_SetClipRegion()
- gfx_Ellipse(x, y, xrad, yrad, colour)
- gfx_EllipseFilled(x, y, xrad, yrad, colour)
- gfx_Button(state, x, y, buttonColour, textColour, font, textWidth, textHeight, text)
- gfx_Panel(state, x, y, width, height, colour)
- gfx_Slider(mode, x1, y1, x2, y2, colour, scale, value)
- gfx_ScreenCopyPaste(xs, ys, xd, yd, width, height)
- gfx_RGBto565(RED, GREEN, BLUE)
- gfx_332to565(COLOUR8BIT)
- gfx_Selection(index, bgcolor, textcolor)
- gfx_TriangleFilled(x1, y1, x2, y2, x3, y3, colr)
- gfx_PolygonFilled(n, &vx, &vy, colr)
- gfx-Origin(x, y)
- gfx_Get(mode)
- gfx_ClipWindow(x1, y1, x2, y2)
- gfx_Set(function, value)

gfx_Set shortcuts:

- gfx_PenSize(mode)
- gfx_BGcolour(colour)
- gfx_ObjectColour(colour)
- gfx_Clipping(mode)
- gfx_TransparentColour(colour)
- gfx_Transparency(mode)
- gfx_FrameDelay(delay)
- gfx_ScreenMode(delay)
- gfx_OutlineColour(colour)
- gfx_Contrast(value)
- gfx_LinePattern(pattern)
- gfx_ColourMode(mode)
- gfx_BevelWidth(mode)
- gfx_BevelShadow(value)
- gfx_Xorigin(offset)
- gfx_Yorigin(offset)

2.7 Display I/O Functions:

- disp_SetReg(register, data)
- disp_setGRAM(x1, y1, x2, y2)
- disp_WrGRAM(colour)
- disp_WriteControl(value)
- disp_WriteWord(value)
- disp_ReadWord()
- disp_Sync(line)

2.8 Media Functions (SD/SDHC memory Card or Serial Flash chip):

- media_Init()
- media_SetAdd(HIword, LOword)
- media_SetSector(HIword, LOword)
- media_RdSector(Destination_Address)
- media_WrSector(Source_Address)
- media_ReadByte()
- media_ReadWord()
- media_WriteByte(byte_val)
- media_WriteWord(word_val)

- media_Flush()
- media_Image(x, y)
- media_Video(x, y)
- media_VideoFrame(x, y, frameNumber)

2.9 Flash Memory chip Functions:

- flash_SIG()
- flash_ID()
- flash_BulkErase()
- flash_BlockErase(blockAddress)

2.10 SPI Control Functions:

- spi_Init(speed, input_mode, output_mode)
- spi_Read()
- spi_Write(byte)
- spi_Disable()

2.11 Serial (UART) Communications Functions:

- setbaud(rate)
- com_SetBaud(comport, baudrate/10)
- serin() or serin1()
- serout(char) or serout1(char)
- com_Init(buffer, buffsize, qualifier) or com1_Init(buffer, buffsize, qualifier)
- com_Reset() or com1_Reset()
- com_Count() or com1_Count()
- com_Full() or com1_Full()
- com_Error() or com1_Error()
- com_Sync() or com1_Sync()
- com_TXbuffer(buf, bufsize, pin) or com1_TXbuffer(buf, bufsize, pin)
- com_TXcount() or com1_TXcount()
- com_TXemptyEvent(function) or com1_TXemptyEvent(function)

2.12 I2C BUS Master Function

- func I2C_Open(Speed)
- func I2C_Close()
- func I2C_Start()
- func I2C_Stop()
- func I2C_Restart()
- func I2C_Read()
- func I2C_Write(byte)
- func I2C_Ack()
- func I2C_Nack()
- func I2C_AckStatus()
- func I2C_AckPoll(control)
- func I2C_Idle()
- func I2C_Gets(buffer, size)
- func I2C_Getn(buffer, size)
- func I2C_Puts(buffer)
- func I2C_Putn(buffer, count)

2.13 Timer Functions:

- sys_T()
- sys_T_HI()
- sys_SetTimer(timernum, value)
- sys_GetTimer(timernum)

- sys_SetTimerEvent("timernum","function")
- sys_EventQueue()
- sys_EventsPostpone()
- sys_EventsResume()
- sys_Sleep(units)
- iterator(offset)

2.14 FAT16 File Functions:

- file_Error()
- file_Count(filename)
- file_Dir(filename)
- file_FindFirst(fname)
- file_FindNext()
- file_Exists(fname)
- file_Open(fname, mode)
- file_Close(handle)
- file_Read(destination, size, handle)
- file_Seek(handle, HiWord, LoWord)
- file_Index(handle, Hisize, Losize, recordnum)
- file_Tell(handle, &HiWord, &LoWord)
- file_Write(Source, size, handle)
- file_Size(handle, &HiWord, &LoWord)
- file_Image(x, y, handle)
- file_ScreenCapture(x, y, width, height, handle)
- file_PutC(char, handle)
- file_GetC(handle)
- file_PutW(word, handle)
- file_GetW(handle)
- file_PutS(source, handle)
- file_GetS(*String, size, handle)
- file_Erase(fname)
- file_Rewind(handle)
- file_LoadFunction(fname.4XE)
- file_Run(fname..4XE, arglistptr)
- file_Exec(fname..4XE, arglistptr)
- file_LoadImageControl(fname1, fname2, mode)
- file_Mount()
- file_Unmount()
- file_PlayWAV

2.15 Sound Control Functions:

- Snd_Volume(var)
- Snd_Pitch(pitch)
- Snd_BufSize(var)
- Snd_Stop()
- Snd_Pause()
- Snd_Continue()
- Snd_Playing()

2.16 String Class Functions:

- str_Ptr(&var)
- str_GetD(&ptr, &var)
- str_GetW(&ptr, &var)
- str_GetHexW(&ptr, &var)

- str_GetC(&ptr, &var)
- str_GetByte(ptr)
- str_GetWord(ptr)
- str_PutByte(ptr, val)
- str_PutWord(ptr, val)
- str_Match(&ptr, *str)
- str_MatchI(&ptr, *str)
- str_Find(&ptr, *str)
- str_FindI(&ptr, *str)
- str_Length(ptr)
- str_Printf(&ptr, *format)
- str_Cat(&destination, &Source)
- str_CatN(&ptr, str, count)
- str_ByteMove(src, dest, count)
- str_Copy(dest, src)
- str_CopyN(dest, src, count)

2.17 Touch Screen Functions: (Touch functions do not apply to uVGA-II(GFX) module)

- touch_DetectRegion(x1, y1, x2, y2)
- touch_Set(mode)
- touch_Get(mode)

2.18 Image Control Functions:

- img_SetPosition(handle, index, xpos, ypos)
- img_Enable(handle, index)
- img_Disable(handle, index)
- img_Darken(handle, index)
- img_Lighten(handle, index)
- img_SetWord(handle, index, offset, word)
- img_GetWord(handle, index, offset)
- img_Show(handle, index)
- img_SetAttributes(handle, index, value)
- img_ClearAttributes(handle, index, value)
- img_Touched(handle, index)

2.19 Memory Allocation Functions:

- mem_Alloc(size)
- mem_Allocv(size)
- mem_Allocz(size)
- mem_Realloc(ptr, size)
- mem_Free(allocation)
- mem_Heap()
- mem_Set(ptr, char, size)
- mem_Copy(source, destination, count)
- mem_Compare(ptr1, ptr2, count)

2.20 General Purpose Functions:

- pause(time)
- lookup8 (**key**, byteConstList)
- lookup16 (**key**, wordConstList)

2.1. GPIO Functions

Summary of Functions in this section:

- `pin_Set(mode, pin)`
 - OUTPUT, INPUT
- `pin_HI(pin)`
- `pin_HI(pin)`
- `pin_LO(pin)`
- `pin_Read(pin)`
- `bus_In()`
- `bus_Out("var")`
- `bus_Set("var")`
- `bus_Write("var")`
- `bus_Read("var")`

2.1.1. pin_Set(mode, pin)

Syntax	<code>pin_Set(mode, pin);</code>																																																				
Arguments	mode, pin																																																				
	mode	A value (usually a constant) specifying the pin operation.																																																			
	pin	A value (usually a constant) specifying the pin number.																																																			
	The arguments can be a variable, array element, expression or constant.																																																				
Returns	nothing																																																				
Description	<p>PICASO-GFX2 has limited but powerful I/O.</p> <p>There are pre-defined constants for mode and pin:</p> <table border="1"> <thead> <tr> <th>Pin constants</th> <th>Pin number on the PICASO-GFX2 chip</th> <th>Remarks</th> </tr> </thead> <tbody> <tr> <td>IO1_PIN</td> <td>pin 1</td> <td></td> </tr> <tr> <td>IO2_PIN</td> <td>pin 64</td> <td></td> </tr> <tr> <td>IO3_PIN</td> <td>pin 63</td> <td></td> </tr> <tr> <td>IO4_PIN</td> <td>pin 62</td> <td>also used for BUS_RD</td> </tr> <tr> <td>IO5_PIN</td> <td>pin 44</td> <td>also used for BUS_WR</td> </tr> <tr> <td>BACKLITE</td> <td>Back-light control pin.</td> <td>Used internally. Permanently set as Output. HIGH: BACKLITE ON LOW : BACKLITE OFF</td> </tr> <tr> <td>AUDIO_ENABLE</td> <td>Amplifier Chip control pin.</td> <td>Used internally. Permanently set as Output HIGH: Amplifier OFF LOW : Amplifier ON</td> </tr> </tbody> </table> <table border="1"> <thead> <tr> <th>mode constants</th> <th>mode value</th> <th>meaning</th> <th>IO1</th> <th>IO2</th> <th>IO3</th> <th>IO4</th> <th>IO5</th> </tr> </thead> <tbody> <tr> <td>OUTPUT</td> <td>0</td> <td>Pin is set to an output</td> <td>YES</td> <td>YES</td> <td>YES</td> <td>YES</td> <td>YES</td> </tr> <tr> <td>INPUT</td> <td>1</td> <td>Pin is set to an input</td> <td>YES</td> <td>YES</td> <td>YES</td> <td>YES</td> <td>YES</td> </tr> </tbody> </table>					Pin constants	Pin number on the PICASO-GFX2 chip	Remarks	IO1_PIN	pin 1		IO2_PIN	pin 64		IO3_PIN	pin 63		IO4_PIN	pin 62	also used for BUS_RD	IO5_PIN	pin 44	also used for BUS_WR	BACKLITE	Back-light control pin.	Used internally. Permanently set as Output. HIGH : BACKLITE ON LOW : BACKLITE OFF	AUDIO_ENABLE	Amplifier Chip control pin.	Used internally. Permanently set as Output HIGH : Amplifier OFF LOW : Amplifier ON	mode constants	mode value	meaning	IO1	IO2	IO3	IO4	IO5	OUTPUT	0	Pin is set to an output	YES	YES	YES	YES	YES	INPUT	1	Pin is set to an input	YES	YES	YES	YES	YES
Pin constants	Pin number on the PICASO-GFX2 chip	Remarks																																																			
IO1_PIN	pin 1																																																				
IO2_PIN	pin 64																																																				
IO3_PIN	pin 63																																																				
IO4_PIN	pin 62	also used for BUS_RD																																																			
IO5_PIN	pin 44	also used for BUS_WR																																																			
BACKLITE	Back-light control pin.	Used internally. Permanently set as Output. HIGH : BACKLITE ON LOW : BACKLITE OFF																																																			
AUDIO_ENABLE	Amplifier Chip control pin.	Used internally. Permanently set as Output HIGH : Amplifier OFF LOW : Amplifier ON																																																			
mode constants	mode value	meaning	IO1	IO2	IO3	IO4	IO5																																														
OUTPUT	0	Pin is set to an output	YES	YES	YES	YES	YES																																														
INPUT	1	Pin is set to an input	YES	YES	YES	YES	YES																																														
Example	<pre>pin_Set(OUTPUT, IO2_PIN); // set IO2 to be used as an output pin_Set(INPUT, IO1_PIN); // set IO1 to be used as an input</pre>																																																				

2.1.2. pin_HI(pin)

Syntax	<code>pin_HI(pin);</code>	
Arguments	pin	
	pin	A value (usually a constant) specifying the pin number.
	The arguments can be a variable, array element, expression or constant.	
Returns	nothing	
Description	Outputs a "High" level (logic 1) on the appropriate pin that was previously selected as an Output. If the pin is not already set to an output, it is automatically made an output.	
Example	<code>pin_HI(IO2_PIN); // output a Logic 1 on IO2 pin</code>	

2.1.3. pin_LO(pin)

Syntax	<code>pin_LO(pin);</code>	
Arguments	pin	
	pin	A value (usually a constant) specifying the pin number.
	The arguments can be a variable, array element, expression or constant.	
Returns	nothing	
Description	Outputs a "Low" level (logic 0) on the appropriate pin that was previously selected as an Output. If the pin is not already set to an output, it is automatically made an output.	
Example	<code>pin_LO(IO1_PIN); // output a Logic 0 on IO1 pin</code>	

2.1.4. pin_Read(pin)

Syntax	<code>pin_Read(pin);</code>	
Arguments	pin	
	pin	A value (usually a constant) specifying the pin number.
	The arguments can be a variable, array element, expression or constant.	
Returns	value	
	value	Returns a Logic 1 (0x0001) or a Logic 0 (0x0000) or the analogue value of the input pin.
Description	Reads the logic state of the pin that was previously selected as an Input. Returns a "Low" (logic 0) or "High" (logic 1).	
Example	<pre> if(pin_Read(IO1_PIN) == 1) // read the value on IO1 calc_Threshold(); else ... </pre>	

2.1.5. bus_In()

Syntax	<code>bus_In();</code>	
Arguments	none	
Returns	value	
	value	Returns the state of the bus as an 8bit value.
Description	Returns the state of the bus as an 8bit value in to the lower byte of the assigned variable. Note: The BUS_RD and BUS_WR pins are not affected.	
Example	<pre>var1 := bus_In();</pre> <p>The lower byte of var1 will get loaded with the state of the bus.</p>	

2.1.6. bus_Out(arg)

Syntax	<code>bus_Out(arg1);</code>	
Argument	arg	
	arg	A value (usually a constant) specifying the pin number.
	The arguments can be a variable, array element, expression or constant.	
Returns	Nothing	
Description	The lower byte of the argument is placed on the 8bit wide bus. The upper byte of the argument is ignored. Note: The BUS_RD and BUS_WR pins are not affected. Any BUS pins that are set to inputs are not affected.	
Example	<pre>Var temp; temp := 0x0015; bus_Out(temp); // Set the Bus output</pre>	

2.1.7. bus_Set(arg)

Syntax	<code>bus_Set(arg1);</code>	
Arguments	arg	
	arg	A value (usually a constant) specifying the pin number. '1' sets a pin to be an input '0' sets a pin to be output.
	The arguments can be a variable, array element, expression or constant.	
Returns	Nothing	
Description	The lower 8 bits of arg1 are placed in the BUS direction register. a '1' sets a pin to be an input, a '0' sets a pin to be output. The upper 8 bits of arg1 are ignored. The BUS_RD and BUS_WR pins are not affected.	
Example	<pre>var arg1; arg1 := 0xAA; // bus_Set(arg1); // Set the bus to value specified to arg1</pre>	

2.1.8. bus_Write(data)

Syntax	<code>bus_Write(data);</code>	
Arguments	data	
	data	The lower 8 bits of data are sent to the bus. The argument can be a variable, array element, expression or constant.
Returns	nothing	
Description	The lower 8 bits of arg1 are placed on the BUS, then, after a settling delay of approx 50nsec, the BUS_WR pin is strobed LO for approx 50nsec then set back HI. The upper 8 bits of arg1 are ignored. Note: The BUS_WR pin is automatically pre-set to an output to ensure BUS write integrity.	
Example	<pre>var data1 ; data1 := 0x05; bus_Write(data1);</pre>	

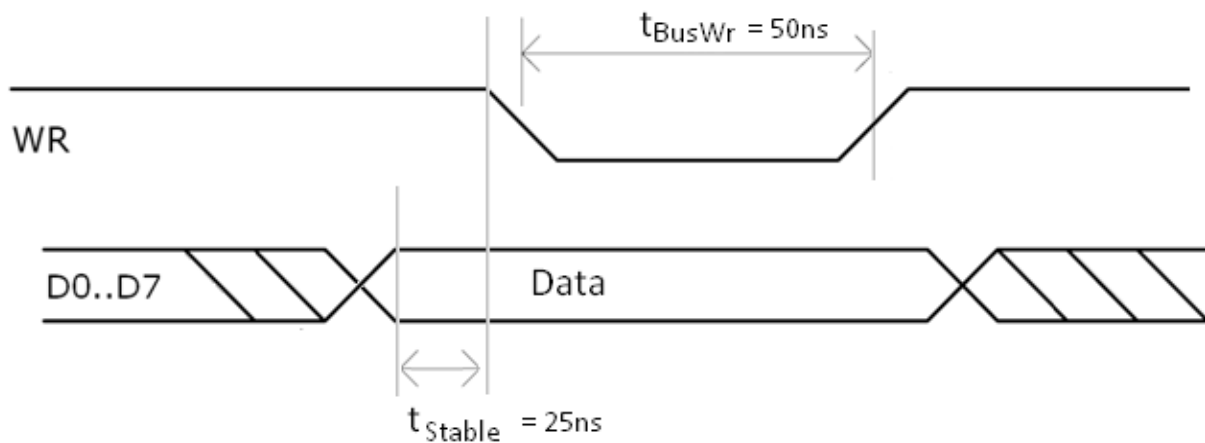

2.1.9. bus_Read()

Syntax	<code>bus_Read();</code>	
Arguments	none	
Returns	value	
	value	Returns the state of the bus as an 8bit value.
Description	<p>Returns the state of the bus as an 8bit value in to the lower byte of the assigned variable.</p> <p>Note: The BUS_RD and BUS_WR pins are not affected. The BUS_RD pin set to LO, then, after a settling delay of approx 50nsec, the BUS is read into the lower 8 bits of the assigned variable (the upper 8 bits being set to 0) the BUS_RD pin is then set back to a HI level. The BUS_RD pin is automatically pre-set to an output to ensure BUS write integrity.</p>	
Example	<pre>var1 := bus_Read();</pre> <p>The lower byte of var1 will get loaded with the state of the bus.</p>	

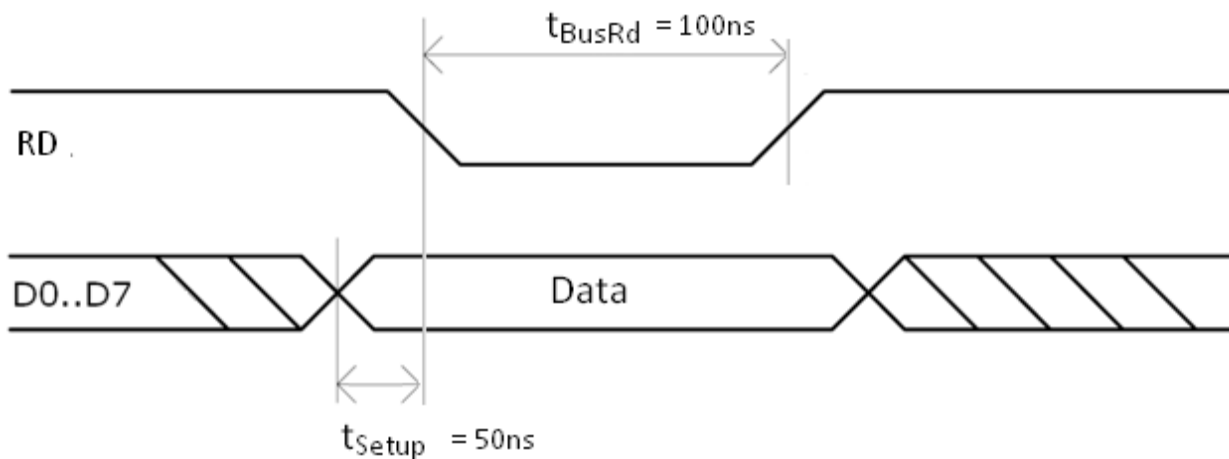

2.2. System Memory Access Functions

Summary of Functions in this section:

- peekW(address)
- pokeW(address, word_value)

2.2.1. peekW(address)

Syntax	peekW(address);	
Arguments	address	
	address	The address of a memory word. The address is usually a pre-defined system register address constant, (see the address constants for all the system word sized registers in section 3, table 3.2).
	The arguments can be a variable, array element, expression or constant.	
Returns	word_value	
	word_value	The 16 bit value stored at address .
Description	This function returns the 16 bit value that is stored at address .	
Example	<pre>var myvar; myvar := peekW(SYSTEM_TIMER_LO);</pre>	
	This example places the low word of the 32 bit system timer in myvar .	

2.2.2. pokeW(address, word_value)

Syntax	<code>pokeW(address, word_value);</code>	
Arguments	address, word_value	
	address	The address of a memory word. The address is usually a pre-defined system register address constant, (see the address constants for all the system word sized registers in section 3, table 3.2).
	word_value	The 16 bit word_value will be stored at address .
	The arguments can be a variable, array element, expression or constant.	
Returns	boolean	
	boolean	Returns TRUE if poke address was a legal address (usually ignored).
Description	This function writes a 16 bit value to a location specified by address .	
Example	<code>pokeW(TIMER2, 5000);</code>	
	This example sets TIMER2 to 5 seconds.	

2.3. Maths Functions

Summary of Functions in this section:

- ABS(value)
- MIN(value1, value2)
- MAX(value1, value2)
- SWAP(&var1, &var2)
- SIN(angle)
- COS(angle)
- RAND()
- SEED(number)
- SQRT(number)
- OVF ()
- umul_1616(&res32, val1, val2)
- uadd_3232(&res32, &val1, &val2)
- usub_3232(&res32, &val1, &val2)
- ucmp_3232(&val1, &val2)

2.3.1. ABS(value)

Syntax	ABS(value);	
Arguments	value	
	value	a variable, array element, expression or constant.
	The arguments can be a variable, array element, expression or constant.	
Returns	value	
	value	Returns the absolute value.
Description	This function returns the absolute value of value .	
Example	<pre>var myvar, number; number := -100; myvar := ABS(number * 5);</pre>	
	This example returns 500 in variable myvar .	

2.3.2. MIN(value1, value2)

Syntax	MIN(value1, value2);	
Arguments	value1, value2	
	value1	a variable, array element, expression or constant.
	value2	a variable, array element, expression or constant.
	The arguments can be a variable, array element, expression or constant.	
Returns	value	
	value	the smaller of the two values.
Description	This function returns the the smaller of value1 and value2 .	
Example	<pre>var myvar, number1, number2; number1 := 33; number2 := 66; myvar := MIN(number1, number2);</pre>	
	This example returns 33 in variable myvar .	

2.3.3. MAX(value1, value2)

Syntax	MAX(value1, value2);	
Arguments	value1, value2	
	value1	a variable, array element, expression or constant.
	value2	a variable, array element, expression or constant.
	The arguments can be a variable, array element, expression or constant.	
Returns	value	
	value	the larger of the two values.
Description	This function returns the the larger of value1 and value2 .	
Example	<pre>var myvar, number1, number2; number1 := 33; number2 := 66; myvar := MAX(number1, number2);</pre>	
	This example returns 66 in variable myvar .	

2.3.4. SWAP(&var1, &var2)

Syntax	SWAP(&value1, &value2);	
Arguments	&var1, &var2	
	&var1	The address of the first variable.
	&var2	The address of the second variable.
	The arguments can only be a variable or an array element.	
Returns	nothing	
Description	Given the addresses of two variables (var1 and var2), the values at these addresses are swapped.	
Example	<pre>var number1, number2; number1 := 33; number2 := 66; SWAP(&number1, &number2);</pre> <p>This example swaps the values in number1 and number2. After the function is executed, number1 will hold 66, and number2 will hold 33.</p>	

2.3.5. SIN(angle)

Syntax	SIN(angle);	
Arguments	angle	
	angle	The angle in degrees. (Note: The input value is automatically shifted to lie within 0-359 degrees)
	The arguments can be a variable, array element, expression or constant.	
Returns	result	
	result	The sine in radians of an argument specified in degrees. The returned value range is from 127 to -127 which is a more useful representation for graphics work. The real sine values vary from 1.0 to -1.0 so appropriate scaling must be done in user code as required.
Description	This function returns the sine of an angle	
Example	<pre>var myvar, angle; angle := 133; myvar := SIN(angle);</pre> This example returns 92 in variable myvar .	

2.3.6. COS(angle)

Syntax	COS(angle);	
Arguments	angle	
	angle	The angle in degrees. (Note: The input value is automatically shifted to lie within 0-359 degrees)
	The arguments can be a variable, array element, expression or constant.	
Returns	result	
	result	The cosine in radians of an argument specified in degrees. The returned value range is from 127 to -127 which is a more useful representation for graphics work. The real sine values vary from 1.0 to -1.0 so appropriate scaling must be done in user code as required.
Description	This function returns the cosine of an angle	
Example	<pre>var myvar, angle; angle := 133; myvar := COS(angle);</pre> This example returns -86 in variable myvar .	

2.3.7. RAND()

Syntax	RAND();	
Arguments	none	
Returns	value	Returns a pseudo random signed number ranging from -32768 to +32767 each time the function is called. The random number generator may first be seeded by using the SEED(number) function. The seed will generate a pseudo random sequence that is repeatable. You can use the modulo operator (%) to return a number within a certain range, eg n := RAND() % 100; will return a random number between -99 and +99. If you are using random number generation for random graphics points, or only require a positive number set, you will need to use the ABS function so only a positive number is returned, eg: X1 := ABS(RAND() % 100); will set co-ordinate X1 between 0 and 99. Note that if the random number generator is not seeded, the first number returned after reset or power up will be zero. This is normal behavior.
Description	This function returns a pseudo random signed number ranging from -32768 to +32767	
Example	<pre>SEED(1234); print(RAND(), " ", RAND());</pre> <p>This example will print 3558, 1960 to the display.</p>	

2.3.8. SEED(number)

Syntax	SEED(number);	
Arguments	number	
	number	Specifies the seed value for the pseudo random number generator.
	The arguments can be a variable, array element, expression or constant.	
Returns	nothing	
Description	This function seeds the pseudo random number generator so it will generate a new repeatable sequence. The seed value can be a positive or negative number.	
Example	<pre>SEED(-50); print(RAND(), " ", " ", RAND());</pre> <p>This example will print 30129, 27266 to the display.</p>	

2.3.9. SQRT(number)

Syntax	SQRT(number);	
Arguments	number	
	number	Specifies the positive number for the SQRT function.
	The arguments can be a variable, array element, expression or constant.	
Returns	value	
	value	This function returns the integer square root which is the greatest integer less than or equal to the square root of number .
Description	This function returns the integer square root of a number.	
Example	<pre>var myvar; myvar := SQRT(26000);</pre>	
	This example returns 161 in variable myvar which is the integer square root of 26000.	

2.3.10. OVF()

Syntax	OVF();	
Arguments	none	
Returns	value	
	value	the high order 16 bits from certain math and shift functions.
Description	This function returns the high order 16 bits from certain math and shift functions. It is extremely useful for calculating 32 bit address offsets for MEDIA access. It can be used with the shift operations, addition, subtraction, multiplication and modulus operations.	
Example	<pre>var loWord, hiWord; loWord := 0x2710 * 0x2710; // (10000 * 10000 in hex format) hiWord := OVF(); print ("0x", [HEX] hiWord, [HEX] loWord);</pre> <p>This example will print 0x05F5E100 to the display , which is 100,000,000 in hexadecimal</p>	

2.3.11. CY()

Syntax	CY();	
Arguments	none	
Returns	Status	
	Status	Returns Status of carry, 0 or 1.
Description	This function returns the carry status of an unsigned overflow from any 16 or 32bit additions or subtractions.	
Example	<pre>var myvar; myvar := 0xFFFF8 + 9; // result = 1 print("myvar ", myvar, "\nCarry ", CY(), "\n"); // carry = 1</pre> <p>This example will print myvar 1 Carry 1</p>	

2.3.12. umul_1616(&res32, val1, val2)

Syntax	<code>umul_1616(&res32, val1, val2);</code>	
Arguments	<code>&res32, val1, val2</code>	
	&res32	Points to 32bit result register.
	val1	16bit register or constant
	val2	16bit register or constant
Returns	Pointer	
	Pointer	Returns a pointer to the 32bit result. Carry and overflow are not affected.
Description	Performs an unsigned multiply of 2 x 16bit values placing the 32bit result in a 2 word array.	
Example	<pre>var val32[2]; var p; umul_1616(val32, 500, 2000); p := str_Ptr(val32); str_Printf(&p, "%ld");</pre> <p>This example prints 1000000</p>	

2.3.13. uadd_3232(&res32, &val1, &val2)

Syntax	<code>uadd_3232(&res32, &val1, &val2);</code>	
Arguments	<code>&res32, &val1, &val2</code>	
	&res32	Points to 32bit result register.
	&val1	points to 32bit augend
	&val2	points to 32bit addend
Returns	Value	
	Value	Returns 1 on 32bit unsigned overflow (carry). Carry flag is also set on 32bit unsigned overflow and can be read with the CY() function.
Description	Performs an unsigned addition of 2 x 32bit values placing the 32bit result in a 2 word array.	
Example	<pre>var carry, valA[2], valB[2], Result[2]; var p; valA[0] := 0; valA[1] := 1; valB[0] := 0; valB[1] := 1; carry := uadd_3232(Result, valA, valB); p := str_Ptr(Result); print("0x"); str_Printf(&p, "%lX"); //prints the value at pointer in Hex long format.</pre> <p>This example will print 0x20000</p>	

2.3.14. `usub_3232(&res32, &val1, &val2)`

Syntax	<code>uadd_3232(&res32, &val1, &val2);</code>	
Arguments	<code>&res32, &val1, &val2</code>	
	&res32	Points to 32bit result register.
	&val1	points to 32bit augend
	&val2	points to 32bit addend
Returns	Value	
	Value	Returns 1 on 32bit unsigned overflow (carry). Carry flag is also set on 32bit unsigned overflow and can be read with the <code>CY()</code> function.
Description	Performs an unsigned subtraction of 2 x 32bit values placing the 32bit result in a 2 word array.	
Example	<pre> var carry, valA[2], valB[2], Result[2]; var p; valA[0] := 0; valA[1] := 0xFFFF; valB[0] := 0; valB[1] := 0xEFFF; carry := usub_3232(Result, valA, valB); p := str_Ptr(Result); print("0x"); str_Printf(&p, "%lX"); repeat forever </pre> <p>This example will print 0x10000000</p>	

2.3.15. `ucmp_3232(&val1, &val2)`

Syntax	<code>ucmp_3232(&val1, &val2);</code>	
Arguments	&val1, &val2	
	&val1	points to 32bit augend
	&val2	points to 32bit addend
Returns	Value	
	Value	0 if equal 1 if val1 > val2 -1 if val1 < val2 This function does not affect the carry flag.
Description	Performs an unsigned comparison of 2 x 32bit values. The result of the subtraction is returned.	
Example	<pre> var carry, valA[2], valB[2], Result; valA[0] := 0; valA[1] := 0xFFFF; valB[0] := 0; valB[1] := 0xEFFF; Result := cmp_3232(valA, valB); //val1 > val2 print(Result); repeat forever </pre> <p>This example will print 1.</p>	

2.4. Text and String Functions

Summary of Functions in this section:

- txt_MoveCursor(line, column)
- putch(char)
- putstr(pointer)
- putnum(format, value)
- print(...)
- to(outstream)
- charwidth('char')
- charheight('char')
- strwidth(pointer)
- strheight()
- strlen(pointer)
- txt_Set(function, value)

txt_Set shortcuts:

- txt_FGcolour(colour)
- txt_BGcolour(colour)
- txt_FontID(id)
- txt_Width(multiplier)
- txt_Height(multiplier)
- txt_Xgap(pixelcount)
- txt_Ygap(pixelcount)
- txt_Delay(millisecs)
- txt_Opacity(mode)
- txt_Bold(mode)
- txt_Italic(mode)
- txt_Inverse(mode)
- txt_Underlined(mode)
- txt_Attributes(value)
- txt_Wrap

2.4.1. txt_MoveCursor(line, column)

Syntax	<code>txt_MoveCursor(line, column);</code>	
Arguments	line, column	
	line	Holds a positive value for the required line position.
	newColour	Holds a positive value for the required column position.
	The arguments can be a variable, array element, expression or constant	
Returns	nothing	
Description	Moves the text cursor to a screen position set by line and column parameters. The line and column position is calculated, based on the size and scaling factor for the currently selected font. When text is outputted to screen it will be displayed from this position. The text position could also be set with <code>gfx_MoveTo(...)</code> ; if required to set the text position to an exact pixel location. Note that lines and columns start from 0, so line 0 , column 0 is the top left corner of the display.	
Example	<pre>txt_MoveCursor(4, 9);</pre> <p>This example moves the text origin to the 5th line and the 10th column.</p>	

2.4.2. `putch(char)`

Syntax	<code>putch(char);</code>
Arguments	<code>char</code>
	<code>char</code> Holds a positive value for the required character. The arguments can be a variable, array element, expression or constant
Returns	<code>nothing</code>
Description	<code>putch</code> prints single characters to the current output stream, usually the display.
Example	<pre>var v; v := 0x39; putch(v); // print the number 9 to the current display location putch('\n'); // newline</pre>

2.4.3. putstr(pointer)

Syntax	putstr(pointer);	
Arguments	pointer	
	pointer	A string constant or pointer to a string.
	The argument can be a string constant or pointer to a string, a pointer to an array, or a pointer to a data statement.	
Returns	source	
	source	Returns the pointer to the item that was printed.
Description	<p>putstr prints a string to the current output stream, usually the display. The argument can be a string constant, a pointer to a string, a pointer to an array, or a pointer to a data statement.</p> <p>Note: putstr is more efficient than print for printing single strings.</p> <p>The output of putstr can be redirected to the communications port, the media, or memory using the to(...); function.</p> <p>A string constant is automatically terminated with a zero.</p> <p>A string in a data statement is not automatically terminated with a zero.</p> <p>All variables in 4DGL are 16bit, if an array is used for holding 8 bit characters, each array element packs 1 or 2 characters.</p>	
Example	<pre>//===== // Example #1 - print a string constant //===== putstr("HELLO\n"); //simply print a string constant at current origin //===== // Example #2 - print string via pointer //===== var p; // a var for use as a pointer p := "String Constant\n"; // assign a string constant to pointer s putstr(p); // print the string using the pointer putstr(p+8); // print, offsetting into the string //===== // Example #3 - printing strings from data table //===== #DATA byte message "Week",0 word days sun,mon,tue,wed,thu,fri,sat // pointers to data items byte sun "Sunday\n\0" byte mon "Monday\n\0" byte tue "Tuesday\n\0" byte wed "Wednesday\n\0" byte thu "Thursday\n\0" byte fri "Friday\n\0" byte sat "Saturday\n\0" #END var n; putstr</pre>	

```
n:=0;  
while(n < 7)  
    putstr(days[n++]); // print the days  
wend
```

2.4.4. putnum(format, value)

Syntax	putnum(format, value);	
Arguments	format, value	
	format	A constant that specifies the number format.
	value	The number to be printed.

Number formatting bits supplied by format

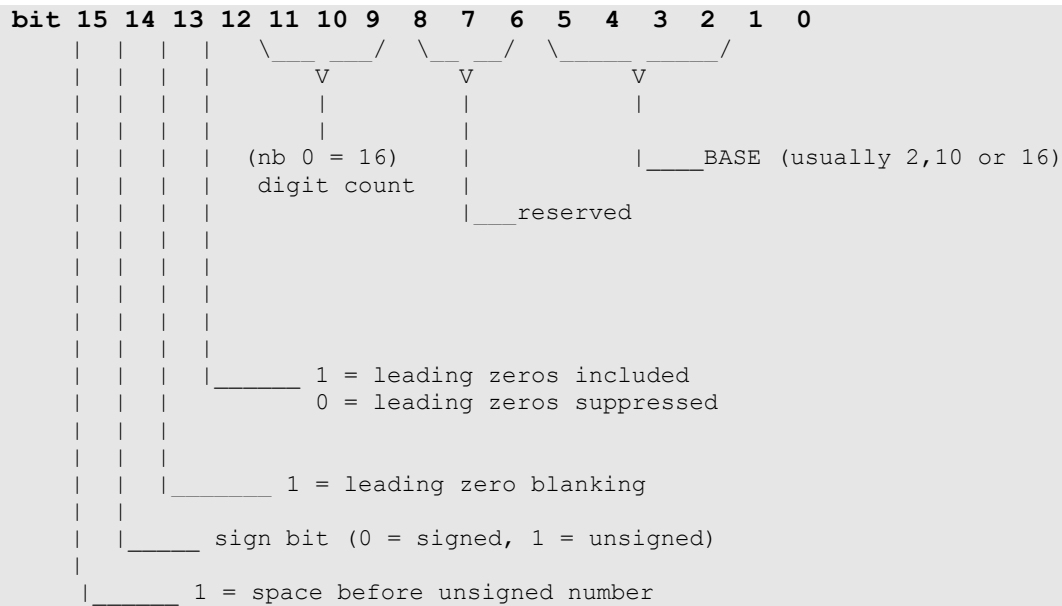

Pre-Defined format constants quick reference

DECIMAL			UNSIGNED DECIMAL			HEX			BINARY		
DEC	DECZ	DECZB	UDEC	UDECZ	UDECZB	HEX	HEXZ	HEXZB	BIN	BINZ	BINZB
DEC1	DEC1Z	DEC1ZB	UDEC1	UDEC1Z	UDEC1ZB	HEX1	HEX1Z	HEX1ZB	BIN1	BIN1Z	BIN1ZB
DEC2	DEC2Z	DEC2ZB	UDEC2	UDEC2Z	UDEC2ZB	HEX2	HEX2Z	HEX1ZB	BIN2	BIN2Z	BIN2ZB
DEC3	DEC3Z	DEC3ZB	UDEC3	UDEC3Z	UDEC3ZB	HEX3	HEX3Z	HEX1ZB	BIN3	BIN3Z	BIN3ZB
DEC4	DEC4Z	DEC4ZB	UDEC4	UDEC4Z	UDEC4ZB	HEX4	HEX4Z	HEX1ZB	BIN4	BIN4Z	BIN4ZB
DEC5	DEC5Z	DEC5ZB	UDEC5	UDEC5Z	UDEC5ZB				BIN5	BIN5Z	BIN5ZB
									BIN6	BIN6Z	BIN6ZB
									BIN7	BIN7Z	BIN7ZB
									BIN8	BIN8Z	BIN8ZB
									BIN9	BIN9Z	BIN9ZB
									BIN10	BIN10Z	BIN10ZB
									BIN11	BIN11Z	BIN11ZB

									BIN12	BIN12Z	BIN12ZB
									BIN13	BIN13Z	BIN13ZB
									BIN14	BIN14Z	BIN14ZB
									BIN15	BIN15Z	BIN15ZB
									BIN16	BIN16Z	BIN16ZB
Returns											
field											
	field	Returns the the default width of the numeric field (digit count), usually ignored.									
Description											
	putnum	prints a 16bit number in various formats to the current output stream, usually the display.									
Example											
	<pre>var v; v := 05678; putnum(HEX, v); // print the number as hex 4 digits putnum(BIN, v); // print the number as binary 16 digits</pre>										

2.4.5. print(...)

Syntax	<code>print(...);</code>
Arguments	See Description
Returns	nothing
Description	<p>4DGL has a versatile <code>print(...)</code> statement for formatting numbers and strings. In it's simplest form, print will simply print a number as can be seen below:</p> <pre>myvar := 100; print(myvar);</pre> <p>This will print 100 to the current output device (usually the display in TEXT mode). Note that if you wish to add a string anywhere within a <code>print(...)</code> statement, just place a quoted string expression and you will be able to mix strings and numbers in a variety of formats. See the following example.</p> <pre>print("the value of myvar is :- ", myvar, "and its 8bit binary representation is:-", [BIN8]myvar);</pre> <p>* Refer the the table in putnum(..) for all the numeric representations available.</p> <p>The <code>print(...)</code> statement will accept directives passed in square brackets to make it print in various ways, for instance, if you wish to print a number in 4 digit hex, use the [HEX4] directive placed in front of the variable to be displayed within the print statement. See the following example.</p> <pre>print("myvar as a 4 digit HEX number is :- ", [HEX4]myvar);</pre> <p>Note that there are 2 print directives that are not part of the numeric set and will be explained separately. these are the [STR] and [CHR] directives.</p> <p>The [STR] directive expects a string pointer to follow:</p> <pre>s := "Hello World"; // assign a string constant to s print("Var 's' points to a string constant at address", s, " which is", [STR] s);</pre> <p>The [CHR] directive prints the character value of a variable.</p> <pre>print("The third character of the string is '", [CHR] *(s+2));</pre> <p>also</p> <pre>print("The value of 'myvar' as an ASCII charater is '", [CHR] myvar);</pre> <p>Note that you can freely mix string pointers, strings, variables and expressions within a print statement. <code>print(...)</code> can also use the <code>to(...)</code> function to redirect it's output to a different output device other than the screen using the function (refer to the to(...) statement for further examples).</p>
Example	<pre>#platform "uOLED-32028-P1_GFX2" //////////////////////////////// // DATA STATEMENT // //////////////////////////////// #DATA</pre>

```

word myData
myString1, Bert, Fred, main, myString2, baud, barney,
0x1111,0x2222,0x3333,0x4444

byte myString1 "Data String OK\n\n",0
byte myString2 "\"(and forward referenced!)\n\n",0
word baud 150,300,600,1200,2400,9600
#END

// this constant is a forward reference
#constant barney 9876

func Fred(var str)
print("string = ", [STR] str);
endfunc

func Bert(var p1, var p2, var p3)
print("hello from Bert\np1=",p1,"np2=",p2, "\np3=",p3,"\n");
return "Bert was here\n";
endfunc

func main()
var fn; // a variable for a handle for the function

txt_Set(FONT_ID, FONT1);

fn := myData[1]; //Get function pointer from data statement index
print( [STR] fn(100,200,300) );
// use it in a statement to prove engine ok

fn := myData[2]; //Get function pointer from data statement index
fn("ABC\n"); // execute the function

// just shows where main lives
print("\naddress of main = code[", myData[3],"]\n\n");
// remember - a var can be a handle, variable, pointer or vector
print( [STR] myData[0]); // pointer table data reference
print( [STR] myData[4]);

repeat forever

endfunc

```

2.4.6. to(outstream)

Syntax	to(outstream);		
Arguments	outstream		
	outstream	A variable or constant specifying the destination for the putch , putstr , putnum and print functions.	
	Predefined Name	Constant	putch(), putstr(), putnum(), print() redirection
	APPEND	0x0000	Output is appended to user array if previous redirection was to an array.
	TEXT	0xF801	Output is directed to the screen (default).
	DSK	0xF802	Output is directed to the most recently open file that has been opened in write mode.
	COM0	0xFF04	Output is redirected to the COM0 (default serial) port.
	COM1	0xFF08	Output is redirected to the COM1 (auxilliary serial) port.
	I2C	0xF820	Output is directed to the I2C port.
	MDA	0xFF40	Output is directed to the SD/SDHC or FLASH media. Warning – be careful writing to a FAT16 formatted card without checking legal partitioned are else the disk formatting will be destroyed.
	(memory pointer)	Array address	Output is redirect to the memory pointer argument.
Returns	nothing		
Description	to() sends the printed output to destinations other than the screen. Normally, print just sends its output to the display in TEXT mode which is the default, however, the output from print can be sent to 'streams', eg – COM0 or COM1 , an open FAT16 file with DSK , to raw media with MDA (media), or to the I2C port with I2C . The to(...) function can also stream to a memory array . Note that once the to(...) function has taken effect, the stream reverts back to the default stream which is TEXT as soon as putch , putstr , putnum or print has completed its action. The APPEND argument is used to append the printed output to the same place as the previous redirection. This is most useful for building string arrays, or adding sequential data to a media stream.		
Example	<pre>//===== // Example #1 - putstr redirection //===== var buf[10]; // a buffer that will hold up to 20 bytes/chars var s; // a var for use as a pointer to(buf); putstr("ONE "); // redirect putstr to the buffer to(APPEND); putstr("TWO "); // and add a couple more items to(APPEND); putstr("THREE\n"); putstr(buf); // print the result while (media_Init()==0); // wait if no SD/SDHC card detected media_SetSector(0, 2); // at sector 2 //media_SetAdd(0, 1024); // (alternatively, use media_SetAdd(), // lower 9 bits ignored). to(MDA); putstr("Hello World"); // now write a ascii test string media_WriteByte('A'); // write a further 3 bytes</pre>		

```
media_WriteByte('B');  
media_WriteByte('C');  
to(MDA); putstr(buf); // write the buffer we prepared earlier  
media_WriteByte(0); // terminate with ASCII zero  
media_Flush();  
media_SetAdd(0, 1024); // reset the media address  
while(char:=media_ReadByte())  
    to(COM0); putch(char); // print the stored string to the COM port  
wend  
repeat forever
```

2.4.7. charwidth('char')

Syntax	<code>charwidth('char');</code>	
Arguments	<code>'char'</code>	
	<code>'char'</code>	The ascii character for the width calculation.
Returns	<code>width</code>	
	<code>width</code>	Returns the width of a single character in pixel units.
Description	<code>charwidth</code> is used to calculate the width in pixel units for a string, based on the currently selected font. The font can be proportional or mono-spaced. If the total width of the string exceeds 255 pixel units, the function will return the 'wrapped' (modulo 8) value.	
Example	<pre>//===== // Example //===== str := "HELLO\nTHERE"; // note that this string spans 2 lines due // to the \n. width := strwidth(str); // get the width of the string, this will // also capture the height. height := strheight(); // note, invoking strwidth also calcs height // which we can now read. // The string above spans 2 lines, strheight(.) will calculate height // correctly for multiple lines. len := strlen(str); // the strlen() function returns the number // of characters in a string. print("\nLength=",len); // NB:- the \n in "HELLO\nTHERE" is counted // as a character. txt_FontID(MS_SanSerif8x12); // select this font w := charwidth('W'); // get a characters width h := charheight('W'); // and height txt_FontID(0); // back to default font print ("\n'W' is " ,w, " pixels wide"); // show width of a character // 'W' in pixel units. print ("\n'W' is " ,h, " pixels high"); // show height of a character // 'W' in pixel units.</pre>	

2.4.8. charheight('char')

Syntax	<code>charheight('char');</code>	
Arguments	<code>'char'</code>	
	<code>'char'</code>	The ascii character for the height calculation.
Returns	<code>width</code>	
	<code>width</code>	Returns the height of a single character in pixel units.
Description	<code>charheight</code> is used to calculate the height in pixel units for a string, based on the currently selected font. The font can be proportional or mono-spaced.	
Example	See <code>example</code> in <code>charwidth()</code>	

2.4.9. `strwidth(pointer)`

Syntax	<code>strwidth(pointer);</code>	
Arguments	<code>pointer</code>	
	<code>pointer</code>	The pointer to a zero (0x00) terminated string.
Returns	<code>width</code>	
	<code>width</code>	Returns the width of a string in pixel units.
Description	<code>strwidth</code> returns the width of a zero terminated string in pixel units. Note that any string constants declared in your program are automatically terminated with a zero as an end marker by the compiler. Any string that you create in the DATA section or MEM section must have a zero added as a terminator for this function to work correctly.	
Example	See <code>example</code> in <code>charwidth()</code>	

2.4.10. strheight()

Syntax	<code>strheight();</code>	
Arguments	none	
Returns	height	
	height	Returns the height of a string in pixel units.
Description	<p>strheight returns the height of a zero terminated string in pixel units. The strwidth function must be called first which makes available width and height. Note that any string constants declared in your program are automatically terminated with a zero as an end marker by the compiler. Any string that you create in the DATA section or MEM section must have a zero added as a terminator for this function to work correctly.</p>	
Example	See <code>example</code> in <code>charwidth()</code>	

2.4.11. strlen(pointer)

Syntax	strlen(pointer);	
Arguments	pointer	
	pointer	The pointer to a zero (0x00) terminated string.
Returns	length	
	length	Returns the length of a string in character units.
Description	<p>strlen returns the length of a zero terminated string in character units. Note that any string constants declared in your program are automatically terminated with a zero as an end marker by the compiler. Any string that you create in the DATA section or MEM section must have a zero added as a terminator for this function to work correctly.</p>	
Example	See <code>example</code> in <code>charwidth()</code>	

2.4.12. txt_Set(function, value)

Syntax	txt_Set(function, value);		
Arguments	function, value		
	function	The function number determines the required action for various text control functions. Usually a constant, but can be a variable, array element, or expression. There are pre-defined constants for each of the functions.	
	value	A variable, array element, expression or constant holding a value for the selected function.	
Returns	nothing		
Description	Given a function number and a value, set the required text control parameter, such as size, colour, and other formatting controls. This function is extremely useful in a loop to select multiple parameters from a data statement or a control array. Note also that each function available for txt_Set has a single parameter 'shortcut' function that has the same effect. (see the Single parameter short-cuts for the txt_Set functions next page)		
	function		value
#	Predefined Name	Description	
0	TEXT_COLOUR	Set the text foreground colour	Colour 0-65535
1	TEXT_HIGHLIGHT	Set the text background colour	Colour 0-65535
2	FONT_ID	Set the required font. 0 or FONT1 = system font 2 Or FONT3 = Default fonts Note: The value could be the name of a custom font included in a users program in a data statement. See examples in the 4DGL Workshop3 IDE.	0 or FONT1 1 or FONT2 2 or FONT3
3	TEXT_WIDTH	Set the text width multiplier.	1 to 16 (Default =1)
4	TEXT_HEIGHT	Set the text height multiplier.	1 to 16 (Default =1)
5	TEXT_XGAP	Set the pixel gap between characters. The gap is in pixel units	0 to 32(Default =0)
6	TEXT_YGAP	Set the pixel gap between lines. The gap is in pixel units.	0 to 32(Default =0)
7	TEXT_PRINTDELAY	Set the delay between character printing	(Default 0msec)
8	TEXT_OPACITY	Selects whether or not the 'background' pixels are drawn (default mode is OPAQUE)	0 or TRANSPARENT 1 or OPAQUE
9	TEXT_BOLD	Embolden text	0 or 1 (ON or OFF)
10	TEXT_ITALIC	Italicise text	0 or 1 (ON or OFF)
11	TEXT_INVERSE	Inverted text	0 or 1 (ON or OFF)
12	TEXT_UNDERLINED	Underlined text	0 or 1 (ON or OFF)
13	TEXT_ATTRIBUTES	Control of functions 9,10,11,12 grouped (bits can be combined by using logical 'or' of bits) nb:- bits 0-3 and 8-15 are reserved	16 or BOLD 32 or ITALIC 64 or INVERSE 128 or UNDERLINED
14	TEXT_WRAP	Sets the pixel position where text wrap will occur at RHS The feature automatically resets when screen mode is changed. The value is in pixel units. Default value is 0.	0 to n(OFF or Value)

Single parameter short-cuts for the txt_Set(..) functions

Function Syntax	Function Action	value
txt_FGcolour()	Set the text foreground colour	Colour 0-65535
txt_BGcolour()	Set the text background colour	Colour 0-65535
txt_FontID(id)	Set the required font. 0 or FONT1 = system font 2 Or FONT3 = Default fonts Note: The value could be the name of a custom font included in a users program in a data statement. See examples in the 4DGL Workshop3 IDE.	0 to 2 or FONT1 FONT2 FONT3
txt_Width(multiplier)	Set the text width multiplier (note #6)	1 to 16 (Default =1)
txt_Height(multiplier)	Set the text height multiplier (note #6)	1 to 16 (Default =1)
txt_Xgap(pixelcount)	Set the pixel gap between characters. The gap is in pixel units	0 to 32(Default =0)
txt_Ygap(pixelcount)	Set the pixel gap between lines. The gap is in pixel units.	0 to 32(Default =0)
txt_Delay(millisecs)	Set the delay between character printing .	(not used)
txt_Opacity(mode)	Selects whether or not the 'background' pixels are drawn (default mode is OPAQUE)	0 or TRANSPARENT 1 or OPAQUE
txt_Bold(mode)	Embolden text	0 or 1 (ON or OFF)
txt_Italic(mode)	Italic text	0 or 1 (ON or OFF)
txt_Inverse(mode)	Inverted text	0 or 1 (ON or OFF)
txt_Underlined(mode)	Underlined text	0 or 1 (ON or OFF)
txt_Attributes(value)	Control of functions 9, 10, 11, 12 grouped (bits can be combined by using logical 'OR' of bits) nb:- bits 0-3 and 8-15 are reserved	16 or BOLD 32 or ITALIC 64 or INVERSE 128 or UNDERLINED
txt_Wrap	Sets the pixel position where text wrap will occur at RHS The feature automatically resets when screen mode is changed. The value is in pixel units. Default value is 0.	0 to n(OFF or Value)

2.5. Ctype Functions

Summary of Functions in this section:

- isdigit(char)
- isxdigit(char)
- isupper(char)
- islower(char)
- isalpha(char)
- isalnum(char)
- isprint(char)
- isspace(char)
- iswhite(char)
- toupper(char)
- tolower(char)
- LObyte(var)
- HIbyte(var)
- ByteSwap(var)

2.5.1. isdigit(char)

Syntax	<code>isdigit(char);</code>	
Arguments	<code>char</code>	
	<code>char</code>	Specifies the ASCII character for the test.
Returns	Status	
	Status	0: Character is not as ASCII digit 1: Character is an ASCII digit.
Description	Tests the character parameter and returns a 1 if the character is an ascii digit else returns a 0. Valid range : "0123456789".	
Example	<pre> func main() var ch; var stat; gfx_Cls(); txt_Set(FONT_ID, FONT2); print ("Serial Input Test\n"); print ("Download prog to flash\n"); print ("Then use debug terminal\n"); to(COM0); print("serial input test:\n"); // now just stay in a loop repeat ch := serin(); if (ch != -1) print([CHR] ch); // if a key was received from PC, // print its ascii value if (isdigit(ch)) print("Character is an ASCII digit"); if (isxdigit(ch)) print("Character is ASCII Hexadecimal"); if (isupper(ch)) print("Character is ASCII uppercase letter"); if (islower(ch)) print("Character is ASCII uppercase letter"); if (isalpha(ch)) print("Character is an ASCII uppercase or lowercase"); if (isalnum(ch)) print("Character is an ASCII Alphanumeric"); if (isprint(ch)) print("Character is a printable ASCII"); if (isspace(ch)) print("Character is a space type character"); endif forever endfunc; </pre>	

2.5.2. isxdigit(char)

Syntax	isxdigit(char);	
Arguments	char	
	char	Specifies the ASCII character for the test.
Returns	Status	
	Status	0 : Character is not as ASCII hexadecimal digit 1 : Character is an ASCII hexadecimal digit.
Description	Tests the character parameter and returns a 1 if the character is an ascii hexadecimal digit else returns a 0. Valid range : "0123456789ABCDEF".	
Example	Refer to Sec 2.5.1	

2.5.3. isupper(char)

Syntax	<code>isupper(char);</code>	
Arguments	<code>char</code>	
	<code>char</code>	Specifies the ASCII character for the test.
Returns	Status	
	Status	0: Character is not an ASCII upper case letter. 1: Character is an ASCII upper case letter.
Description	Tests the character parameter and returns a 1 if the character is an ASCII upper case letter else returns a 0. Valid range : "ABCDEF...WXYZ".	
Example	Refer to Sec 2.5.1	

2.5.4. islower(char)

Syntax	<code>islower(char);</code>	
Arguments	<code>char</code>	
	<code>char</code>	Specifies the ASCII character for the test.
Returns	Status	
	Status	0: Character is not an ASCII lower case letter 1: Character is an ASCII lower case letter.
Description	Tests the character parameter and returns a 1 if the character is an ASCII lower case letter else returns a 0. Valid range : "abcd...wxyz".	
Example	Refer to Sec 2.5.1	

2.5.5. isalpha(char)

Syntax	isalpha(char);	
Arguments	char	
	char	Specifies the ASCII character for the test.
Returns	Status	
	Status	0: Character is not as ASCII lower or upper case letter. 1: Character is an ASCII lower or upper case letter..
Description	Tests the character parameter and returns a 1 if the character is an ASCII lower or upper case letter else returns a 0. Valid range : "abcd...wxyz", "ABCD...WXYZ"	
Example	Refer to Sec 2.5.1	

2.5.6. isalnum(char)

Syntax	<code>isalnum(char);</code>	
Arguments	<code>char</code>	
	<code>char</code>	Specifies the ASCII character for the test.
Returns	Status	
	Status	0: Character is not as ASCII Alphanumeric character. 1: Character is an ASCII Alphanumeric character.
Description	Tests the character parameter and returns a 1 if the character is an ASCII Alphanumeric else returns a 0. Valid range : "abcd...wxyz", "ABCD...WXYZ", "0123456789"	
Example	Refer to Sec 2.5.1	

2.5.7. isprint(char)

Syntax	<code>isprint(char);</code>	
Arguments	<code>char</code>	
	<code>char</code>	Specifies the ASCII character for the test.
Returns	Status	
	Status	0: Character is not a printable ASCII character. 1: Character is a printable ASCII character.
Description	Tests the character parameter and returns a 1 if the character is a printable ASCII character else returns a 0. Valid range : 0x20... 0x7F	
Example	Refer to Sec 2.5.1	

2.5.8. isspace(char)

Syntax	<code>isspace(char);</code>	
Arguments	<code>char</code>	
	<code>char</code>	Specifies the ASCII character for the test.
Returns	Status	
	Status	0: Character is not a space type character. 1: Character is a space type character.
Description	Tests the character parameter and returns a 1 if the character is any one of the space type character else returns a 0. Valid range : space, formfeed, newline, carriage return, tab, vertical tab.	
Example	Refer to Sec 2.5.1	

2.5.9. toupper(char)

Syntax	toupper(char);	
Arguments	char	
	char	Specifies the ASCII character for the test.
Returns	Char	
	Char	"ABCD...WXYZ" : If character is lower case letter. char : If character is not a lower case letter..
Description	Tests the character parameter and if the character is a lower case letter it returns the upper case equivalent else returns the passed char. Valid range : "abcd ... wxyz".	
Example	<pre> func main() var ch, Upconvch, Loconvch; var stat; gfx_Cls(); txt_Set(FONT_ID, FONT2); print ("Serial Input Test\n"); print ("Download prog to flash\n"); print ("Then use debug terminal\n"); to(COM0); print("serial input test:\n"); // now just stay in a loop repeat ch := serin(); if (ch != -1) print([CHR] ch); // if a key was received from PC, // print its ascii value if (isupper(ch)) print("Uppercase ASCII found. Converting to lowercase"); Loconvch := tolower(ch); endif if (islower(ch)) print("Lowercase ASCII found. Converting to Uppercase"); Upconvch := toupper(ch); endif endif forever endfunc; </pre>	

2.5.10. tolower(char)

Syntax	<code>tolower(char);</code>	
Arguments	<code>char</code>	
	<code>char</code>	Specifies the ASCII character for the test.
Returns	Status	
	Status	"abcd...wxyz" : If character is upper case letter. char : If character is not a upper case letter...
Description	Tests the character parameter and if the character is a lower case letter it returns the upper case equivalent else returns the passed char. Valid range : "ABCD ... WXYZ".	
Example	Refer to Sec 2.5.9	

2.5.11. LByte(var)

Syntax	LByte(var);	
Arguments	var	
	var	User variable.
Returns	byte	
	byte	Returns the lower byte (lower 8 bit) of a 16 bit variable.
Description	Returns the lower byte (lower 8 bit) of a 16 bit variable.	
Example	<code>myvar := LByte(myvar2);</code>	

2.5.12. HIbyte(var)

Syntax	HIbyte(var);	
Arguments	var	
	var	User variable.
Returns	byte	
	byte	Returns the upper byte (upper 8 bits) of a 16 bit variable.
Description	Returns the upper byte (upper 8 bits) of a 16 bit variable.	
Example	<code>myvar := HIbyte(myvar2);</code>	

2.5.13. ByteSwap(var)

Syntax	ByteSwap(var);	
Arguments	var	
	var	User variable.
Returns	Status	
	Status	Returns the endian swapped value of a 16 bit variable.
Description	Returns the swapped upper and lower bytes of a 16 bit variable.	
Example	<code>myvar := ByteSwap(myvar2);</code>	

2.6. Graphics Functions

Summary of Functions in this section:

- gfx_Cls()
- gfx_ChangeColour(oldColour, newColour)
- gfx_Circle(x, y, radius, colour)
- gfx_CircleFilled(x, y, radius, colour)
- gfx_Line(x1, y1, x2, y2, colour)
- gfx_Hline(y, x1, x2, colour)
- gfx_Vline(x, y1, y2, colour)
- gfx_Rectangle(x1, y1, x2, y2, colour)
- gfx_RectangleFilled(x1, y1, x2, y2, colour)
- gfx_Polyline(n, vx, vy, colour)
- gfx_Polygon(n, vx, vy, colour)
- gfx_Triangle(x1, y1, x2, y2, x3, y3, colour)
- gfx_Dot()
- gfx_Bullet(radius)
- gfx_OrbitInit(&x_dest, &y_dest)
- gfx_Orbit(angle, distance)
- gfx_PutPixel(x, y, colour)
- gfx_GetPixel(x, y)
- gfx_MoveTo(xpos, ypos)
- gfx_MoveRel(xoffset, yoffset)
- gfx_IncX()
- gfx_IncY()
- gfx_LineTo(xpos, ypos)
- gfx_LineRel(xpos, ypos)
- gfx_BoxTo(x2, y2)
- gfx_SetClipRegion()
- gfx_Ellipse(x, y, xrad, yrad, colour)
- gfx_EllipseFilled(x, y, xrad, yrad, colour)
- gfx_Button(state, x, y, buttonColour, textColour, font, textWidth, textHeight, text)
- gfx_Panel(state, x, y, width, height, colour)
- gfx_Slider(mode, x1, y1, x2, y2, colour, scale, value)
- gfx_ScreenCopyPaste(xs, ys, xd, yd, width, height)
- gfx_RGBto565(RED, GREEN, BLUE)
- gfx_332to565(COLOUR8BIT)
- gfx_Selection(index, bgcolor, textcolor)
- gfx_TriangleFilled(x1, y1, x2, y2, x3, y3, colr)
- gfx_PolygonFilled(n, &vx, &vy, colr)
- gfx-Origin(x, y)
- gfx_Get(mode)
- gfx_ClipWindow(x1, y1, x2, y2)
- gfx_Set(function, value)
- **gfx_Set shortcuts:**
 - gfx_PenSize(mode)
 - gfx_BGcolour(colour)
 - gfx_ObjectColour(colour)
 - gfx_Cliping(mode)
 - gfx_TransparentColour(colour)
 - gfx_Transparency(mode)
 - gfx_FrameDelay(delay)
 - gfx_ScreenMode(delay)
 - gfx_OutlineColour(colour)

- gfx_Contrast(value)
- gfx_LinePattern(pattern)
- gfx_ColourMode(mode)
- gfx_BevelWidth(mode)
- gfx_BevelShadow(value)
- gfx_Xorigin(offset)
- gfx_Yorigin(offset)

2.6.1. gfx_Cls()

Syntax	<code>gfx_Cls();</code>
Arguments	none
Returns	nothing
Description	<p>Clear the screen using the current background colour. <code>gfx_Cls()</code> command brings some of the settings back to default; such as,</p> <ul style="list-style-type: none"> • Transparency turned OFF • Outline colour set to BLACK • Opacity set to OPAQUE • Pen set to OUTLINE • Line patterns set to OFF • Right text margin set to full width • Text magnifications set to 1 • All origins set to 0:0 <p>The alternative to maintain settings and clear screen is to draw a filled rectangle with the required background colour.</p>
Example	<pre>gfx_BGcolour (DARKGRAY) ; gfx_Cls () ;</pre> <p>This example clears the entire display using colour DARKGRAY</p>

2.6.2. gfx_ChangeColour(oldColour, newColour)

Syntax	<code>gfx_ChangeColour(oldColour, newColour);</code>	
Arguments	oldColour, newColour	
	oldColour	specifies the sample colour to be changed within the clipping window.
	newColour	specifies the new colour to change all occurrences of old colour within the clipping window.
	The arguments can be a variable, array element, expression or constant	
Returns	nothing	
Description	Changes all oldColour pixels to newColour within the clipping area.	
Example	<pre>func main() txt_Width(3); txt_Height(5); gfx_MoveTo(8,20); print("TEST"); // print the string gfx_SetClipRegion(); // force clipping area to extents of text // just printed. gfx_ChangeColour(BLACK, RED); // test change of background colour repeat forever endfunc</pre> <p>This example prints a test string, forces the clipping area to the extent of the text that was printed, then changes the background colour.</p>	

2.6.3. gfx_Circle(x, y, radius, colour)

Syntax	<code>gfx_Circle(x, y, rad, colour);</code>	
Arguments	<code>x, y, rad, colour</code>	
	<code>x, y</code>	specifies the center of the circle.
	<code>rad</code>	specifies the radius of the circle.
	<code>colour</code>	specifies the colour of the circle.
	The arguments can be a variable, array element, expression or constant	
Returns	nothing	
Description	<p>Draws a circle with centre point x1, y1 with radius r using the specified colour.</p> <p>NB: The default PEN_SIZE is set to OUTLINE, however, if PEN_SIZE is set to SOLID, the circle will be drawn filled, if PEN_SIZE is set to OUTLINE, the circle will be drawn as an outline. If the circle is drawn as SOLID, the outline colour can be specified with <code>gfx_OutlineColour(...)</code>. If OUTLINE_COLOUR is set to 0, no outline is drawn.</p>	
Example	<pre>// assuming PEN_SIZE is OUTLINE gfx_Circle(50,50,30, RED);</pre> <p>This example draws a BLUE circle outline centred at x=50, y=50 with a radius of 30 pixel units.</p>	

2.6.4. gfx_CircleFilled(x, y, radius, colour)

Syntax	<code>gfx_CircleFilled(x, y, rad, colour);</code>	
Arguments	<code>x, y, rad, colour</code>	
	<code>x, y</code>	specifies the center of the circle.
	<code>rad</code>	specifies the radius of the circle.
	<code>colour</code>	specifies the fill colour of the circle.
	The arguments can be a variable, array element, expression or constant	
Returns	<code>nothing</code>	
Description	<p>Draws a SOLID circle with centre point x1, y1 with radius using the specified colour.</p> <p>The outline colour can be specified with <code>gfx_OutlineColour(...)</code>. If <code>OUTLINE_COLOUR</code> is set to 0, no outline is drawn.</p> <p>NB:- The <code>PEN_SIZE</code> is ignored, the circle is always drawn SOLID.</p>	
Example	<pre>if(state == TOUCH_RELEASED) // if there's a release; gfx_CircleFilled(x, y, 10, RED); // we'll draw a solid red circle // of radius=10 on touch release endif</pre>	

2.6.5. `gfx_Line(x1, y1, x2, y2, colour)`

Syntax	<code>gfx_Line(x1, y1, x2, y2, colour);</code>	
Arguments	<code>x1, y1, x2, y2, colour</code>	
	<code>x1, y1</code>	specifies the starting coordinates of the line.
	<code>x2, y2</code>	specifies the ending coordinates of the line.
	<code>colour</code>	specifies the colour of the line.
	The arguments can be a variable, array element, expression or constant	
Returns	nothing	
Description	Draws a line from x1,y1 to x2,y2 using the specified colour. The line is drawn using the current object colour. The current origin is not altered. The line may be tessellated with the <code>gfx_LinePattern(...)</code> function.	
Example	<pre>gfx_Line(100, 100, 10, 10, RED);</pre> <p>This example draws a RED line from x1=10, y1=10 to x2=100, y2=100</p>	

2.6.6. gfx_Hline(y, x1, x2, colour)

Syntax	<code>gfx_Hline(y, x1, x2, colour);</code>	
Arguments	<code>y, x1, x2, colour</code>	
	y	specifies the vertical position of the horizontal line.
	x1, x2	specifies the horizontal end points of the line.
	colour	specifies the colour of the horizontal line.
	The arguments can be a variable, array element, expression or constant	
Returns	nothing	
Description	Draws a fast horizontal line from x1 to x2 at vertical co-ordinate y using colour.	
Example	<code>gfx_Hline(50, 10, 80, RED);</code>	
	This example draws a fast RED horizontal line at y=50, from x1=10 to x2=80	

2.6.7. gfx_Vline(x, y1, y2, colour)

Syntax	<code>gfx_Vline(x, y1, y2, colour);</code>	
Arguments	<code>x, y1, y2, colour</code>	
	<code>x</code>	specifies the horizontal position of the vertical line.
	<code>y1, y2</code>	specifies the vertical end points of the line.
	<code>colour</code>	specifies the colour of the vertical line.
	The arguments can be a variable, array element, expression or constant	
Returns	<code>nothing</code>	
Description	Draws a fast vertical line from y1 to y2 at horizontal co-ordinate x using colour.	
Example	<code>gfx_Vline(20, 30, 70, RED);</code>	
	This example draws a fast RED vertical line at x=20, from y1=30 to y2=70	

2.6.8. gfx_Rectangle(x1, y1, x2, y2, colour)

Syntax	<code>gfx_Rectangle(x1, y1, x2, y2, colour);</code>	
Arguments	<code>x1, y1, x2, y2, colour</code>	
	<code>x1, y1</code>	specifies the top left corner of the rectangle.
	<code>x2, y2</code>	specifies the bottom right corner of the rectangle.
	<code>colour</code>	specifies the colour of the rectangle.
	The arguments can be a variable, array element, expression or constant	
Returns	nothing	
Description	<p>Draws a rectangle from x1, y1 to x2, y2 using the specified colour. The line may be tessellated with the <code>gfx_LinePattern(...)</code> function.</p> <p>NB: The default PEN_SIZE is set to OUTLINE, however, if PEN_SIZE is set to SOLID, the rectangle will be drawn filled, if PEN_SIZE is set to OUTLINE, the rectangle will be drawn as an outline. If the rectangle is drawn as SOLID, the outline colour can be specified with <code>gfx_OutlineColour(...)</code>. If OUTLINE_COLOUR is set to 0, no outline is drawn. The outline may be tessellated with the <code>gfx_LinePattern(...)</code> function.</p>	
Example	<pre>gfx_Rectangle(10, 10, 30, 30, GREEN);</pre> <p>This example draws a GREEN rectangle from x1=10, y1=10 to x2=30, y2=30</p>	

2.6.9. gfx_RectangleFilled(x1, y1, x2, y2, colour)

Syntax	<code>gfx_RectangleFilled(x1, y1, x2, y2, colour);</code>	
Arguments	<code>x1, y1, x2, y2, colour</code>	
	<code>x1, y1</code>	specifies the top left corner of the rectangle.
	<code>x2, y2</code>	specifies the bottom right corner of the rectangle.
	<code>colour</code>	specifies the colour of the rectangle.
	The arguments can be a variable, array element, expression or constant	
Returns	nothing	
Description	<p>Draws a SOLID rectangle from x1, y1 to x2, y2 using the specified colour. The line may be tessellated with the <code>gfx_LinePattern(...)</code> function.</p> <p>The outline colour can be specified with <code>gfx_OutlineColour(...)</code>. If OUTLINE_COLOUR is set to 0, no outline is drawn. The outline may be tessellated with the <code>gfx_LinePattern(...)</code> function.</p> <p>NB:- The PEN_SIZE is ignored, the rectangle is always drawn SOLID.</p>	
Example	<pre>gfx_RectangleFilled(30,30,80,80, RED);</pre> <p>This example draws a filled RED rectangle from x1=30,y1=30 to x2=80,y2=80</p>	

2.6.10. `gfx_Polyline(n, vx, vy, colour)`

Syntax	<code>gfx_Polyline(n, vx, vy, colour);</code>	
Arguments	n, vx, vy, colour	
	n	specifies the number of elements in the x and y arrays specifying the vertices for the polyline.
	vx	specifies the addresses of the storage of the array of elements for the x coordinates of the vertices.
	vy	specifies the addresses of the storage of the array of elements for the y coordinates of the vertices.
	colour	Specifies the colour for the lines
	The arguments can be a variable, array element, expression or constant	
Returns	nothing	
Description	Plots lines between points specified by a pair of arrays using the specified colour. The lines may be tessellated with the <code>gfx_LinePattern(...)</code> function. <code>gfx_Polyline</code> can be used to create complex raster graphics by loading the arrays from serial input or from MEDIA with very little code requirement.	
Example	<pre>#inherit "4DGL_16bitColours.fnc" var vx[20], vy[20]; func main() vx[0] := 36; vy[0] := 110; vx[1] := 36; vy[1] := 80; vx[2] := 50; vy[2] := 80; vx[3] := 50; vy[3] := 110; vx[4] := 76; vy[4] := 104; vx[5] := 85; vy[5] := 80; vx[6] := 94; vy[6] := 104; vx[7] := 76; vy[7] := 70; vx[8] := 85; vy[8] := 76; vx[9] := 94; vy[9] := 70; vx[10] := 110; vy[10] := 66; vx[11] := 110; vy[11] := 80; vx[12] := 100; vy[12] := 90; vx[13] := 120; vy[13] := 90; vx[14] := 110; vy[14] := 80; vx[15] := 101; vy[15] := 70; vx[16] := 110; vy[16] := 76; vx[17] := 119; vy[17] := 70; // house gfx_Rectangle(6, 50, 66, 110, RED); // frame gfx_Triangle(6, 50, 36, 9, 66, 50, YELLOW); // roof gfx_Polyline(4, vx, vy, CYAN); // door // man gfx_Circle(85, 56, 10, BLUE); // head gfx_Line(85, 66, 85, 80, BLUE); // body</pre>	

```
gfx_Polyline(3, vx+4, vy+4, CYAN); // legs
gfx_Polyline(3, vx+7, vy+7, BLUE); // arms

// woman
gfx_Circle(110, 56, 10, PINK); // head
gfx_Polyline(5, vx+10, vy+10, BROWN); // dress
gfx_Line(104, 104, 106, 90, PINK); // left arm
gfx_Line(112, 90, 116, 104, PINK); // right arm
gfx_Polyline(3, vx+15, vy+15, SALMON); // dress

repeat forever

endfunc
```

This example draws a simple scene

2.6.11. `gfx_Polygon(n, vx, vy, colour)`

Syntax	<code>gfx_Polygon(n, vx, vy, colour);</code>	
Arguments	<code>n, vx, vy, colour</code>	
	n	specifies the number of elements in the x and y arrays specifying the vertices for the polygon.
	vx	specifies the addresses of the storage of the array of elements for the x coordinates of the vertices.
	vy	specifies the addresses of the storage of the array of elements for the y coordinates of the vertices.
	colour	Specifies the colour for the polygon
	The arguments can be a variable, array element, expression or constant	
Returns	nothing	
Description	Plots lines between points specified by a pair of arrays using the specified colour. The last point is drawn back to the first point, completing the polygon. The lines may be tessellated with the <code>gfx_LinePattern(...)</code> function. <code>gfx_Polygon</code> can be used to create complex raster graphics by loading the arrays from serial input or from MEDIA with very little code requirement.	
Example	<pre>var vx[7], vy[7]; func main() vx[0] := 10; vy[0] := 10; vx[1] := 35; vy[1] := 5; vx[2] := 80; vy[2] := 10; vx[3] := 60; vy[3] := 25; vx[4] := 80; vy[4] := 40; vx[5] := 35; vy[5] := 50; vx[6] := 10; vy[6] := 40; gfx_Polygon(7, vx, vy, RED); repeat forever endfunc</pre> <p>This example draws a simple polygon</p>	

2.6.12. `gfx_Triangle(x1, y1, x2, y2, x3, y3, colour)`

Syntax	<code>gfx_Triangle(x1, y1, x2, y2, x3, y3, colour);</code>	
Arguments	<code>x1, y1, x2, y2, x3, y3, colour</code>	
	<code>x1, y1</code>	specifies the first vertices of the triangle.
	<code>x2, y2</code>	specifies the second vertices of the triangle.
	<code>x3, y3</code>	specifies the third vertices of the triangle.
	<code>colour</code>	Specifies the colour for the triangle.
	The arguments can be a variable, array element, expression or constant	
Returns	<code>nothing</code>	
Description	Draws a triangle outline between vertices <code>x1,y1</code> , <code>x2,y2</code> and <code>x3,y3</code> using the specified colour. The line may be tessellated with the <code>gfx_LinePattern(...)</code> function.	
Example	<code>gfx_Triangle(10,10,30,10,20,30,CYAN);</code>	
	This example draws a CYAN triangular outline with vertices at 10,10 30,10 20,30	

2.6.13. gfx_Dot()

Syntax	<code>gfx_Dot();</code>
Arguments	none
Returns	nothing
Description	Draws a pixel at at the current origin using the current object colour.
Example	<pre>gfx_MoveTo(40,50); gfx_ObjectColour(0xRED); gfx_Dot();</pre> <p>This example draws a RED pixel at 40,50</p>

2.6.14. gfx_Bullet(radius)

Syntax	<code>gfx_Bullet(radius);</code>	
Arguments	radius	
	rad	specifies the radius of the bullet.
	The arguments can be a variable, array element, expression or constant	
Returns	nothing	
Description	<p>Draws a circle or 'bullet point' with radius <i>r</i> at at the current origin using the current object colour.</p> <p>Note: The default PEN_SIZE is set to OUTLINE, however, if PEN_SIZE is set to SOLID, the circle will be drawn filled, if PEN_SIZE is set to OUTLINE, the circle will be drawn as an outline. If the circle is drawn as SOLID, the outline colour can be specified with gfx_OutlineColour(...).</p>	
Example	<pre>gfx_MoveTo(30, 30); gfx_Bullet(10); // Draw a 10pixel radius Bullet at x=30, y=30.</pre>	

2.6.15. `gfx_OrbitInit(&x_dest, &y_dest)`

Syntax	<code>gfx_OrbitInit(&x_dest, &y_dest);</code>	
Arguments	<code>x_dest, y_dest</code>	
	<code>x_dest, y_dest</code>	specifies the addresses of the storage locations for the orbit calculation.
	The arguments can be a variable, array element, expression or constant	
Returns	nothing	
Description	Sets up the internal pointers for the <code>gfx_Orbit(..)</code> result variables. The <code>&x_orb</code> and <code>&y_orb</code> parameters are the addresses of the variables or array elements that are used to store the result from the <code>gfx_Orbit(..)</code> function.	
Example	<pre>var targetX, targetY; gfx_OrbitInit(&targetX, &targetY);</pre> <p>This example sets the variables that will receive the result from a <code>gfx_Orbit(..)</code> function call</p>	

2.6.16. gfx_Orbit(angle, distance)

Syntax	<code>gfx_Orbit(angle, distance);</code>	
Arguments	angle, distance	
	angle	specifies the angle from the origin to the remote point. The angle is specified in degrees.
	distance	specifies the distance from the origin to the remote point in pixel units.
	The arguments can be a variable, array element, expression or constant	
Returns	nothing	
	Note: result is stored in the variables that were specified with the <code>gfx_OrbitInit(..)</code> function.	
Description	Sets Prior to using this function, the destination address of variables for the calculated coordinates must be set using the <code>gfx_OrbitInit(..)</code> function. The <code>gfx_Orbit(..)</code> function calculates the x, y coordinates of a distant point relative to the current origin, where the only known parameters are the <i>angle</i> and the <i>distance</i> from the current origin. The new coordinates are calculated and then placed in the destination variables that have been previously set with the <code>gfx_OrbitInit(..)</code> function.	
Example	<pre>var targetX, targetY; gfx_OrbitInit(&targetX, &targetY); gfx_MoveTo(30, 30); gfx_Bullet(5) // mark the start point with a small WHITE circle gfx_Orbit(30, 50); // calculate a point 50 pixels away from origin at // 30 degrees gfx_CircleFilled(targetX, targetY, 3, 0xF800); // mark the target point // with a RED circle</pre> <p>See example comments for explanation.</p>	

2.6.17. gfx_PutPixel(x, y, colour)

Syntax	<code>gfx_PutPixel(x, y, colour);</code>	
Arguments	<code>x, y, colour</code>	
	<code>x, y</code>	specifies the screen coordinates of the pixel.
	<code>colour</code>	Specifies the colour of the pixel.
	The arguments can be a variable, array element, expression or constant	
Returns	nothing	
Description	Draws a pixel at position x,y using the specified colour.	
Example	<code>gfx_PutPixel(32, 32, 0xFFFF);</code>	
	This example draws a WHITE pixel at x=32, y=32	

2.6.18. gfx_GetPixel(x, y)

Syntax	<code>gfx_GetPixel(x, y);</code>	
Arguments	<code>x, y</code>	
	<code>x, y</code>	specifies the screen coordinates of the pixel colour to be returned.
	The arguments can be a variable, array element, expression or constant	
Returns	colour	
	<code>colour</code>	The 8 or 16bit colour of the pixel (default 16bit).
Description	Reads the colour value of the pixel at position x,y.	
Example	<pre>gfx_PutPixel(20, 20, 1234); r := gfx_GetPixel(20, 20); print(r);</pre> <p>This example prints 1234, the colour of the pixel that was previously placed.</p>	

2.6.19. gfx_MoveTo(xpos, ypos)

Syntax	gfx_MoveTo(xpos, ypos);	
Arguments	xpos, ypos	
	xpos	specifies the horizontal position of the new origin.
	ypos	specifies the vertical position of the new origin.
	The arguments can be a variable, array element, expression or constant	
Returns	nothing	
Description	Moves the origin to a new position.	
Example	<pre>#inherit "4DGL_16bitColours.fnc" func help() var x, y, state; print("TOUCHE ME"); touch_Set(TOUCH_ENABLE); // lets enable the touch screen while(touch_Get(TOUCH_STATUS) != TOUCH_PRESSED); //Wait for touch // we'll need a place on the screen to start with gfx_MoveTo(touch_Get(TOUCH_GETX), touch_Get(TOUCH_GETY)); gfx_Set(OBJECT_COLOUR, WHITE); // this will be our line colour while(1) state := touch_Get(TOUCH_STATUS); // Look for touch activity x := touch_Get(TOUCH_GETX); // Grab x and the y := touch_Get(TOUCH_GETY); // y coordinates of the touch if(state == TOUCH_PRESSED) // if there's a press gfx_LineTo(x, y); // Draw a line from previous spot endif if(state == TOUCH_RELEASED) // if there's a release; gfx_CircleFilled(x, y, 10, RED); // Draw a solid red circle endif if(state == TOUCH_MOVING) // if there's movement gfx_PutPixel(x, y, LIGHTGREEN); // we'll draw a green pixel endif wend // Repeat forever endfunc</pre>	

2.6.20. gfx_MoveRel(xoffset, yoffset)

Syntax	<code>gfx_MoveRel(xoffset, yoffset);</code>	
Arguments	<code>xoffset, yoffset</code>	
	xoffset	specifies the horizontal offset of the new origin.
	yoffset	specifies the vertical offset of the new origin.
	The arguments can be a variable, array element, expression or constant	
Returns	nothing	
Description	Moves the origin to a new position relative to the old position.	
Example	<pre>gfx_MoveTo(10, 20); gfx_MoveRel(-5, -3); gfx_Dot();</pre> <p>This example draws a pixel using the current object colour at x=5, y=17</p>	

2.6.21. gfx_IncX()

Syntax	<code>gfx_IncX();</code>	
Arguments	none	
Returns	<code>old_origin</code>	
	<code>old_origin</code>	Returns the current X origin before the increment.
Description	Increment the current X origin by 1 pixel unit. The original value is returned before incrementing. The return value can be useful if a function requires the current point before insetting occurs.	
Example	<pre>var n; gfx_MoveTo(20,20); n := 96; while (n--) gfx_ObjectColour(n/3); gfx_Bullet(2); gfx_IncX(); wend</pre> <p>This example draws a simple rounded vertical gradient.</p>	

2.6.22. gfx_IncY()

Syntax	<code>gfx_IncY();</code>	
Arguments	none	
Returns	<code>old_Yorigin</code>	Returns the current Y origin before the increment.
Description	Increment the current Y origin by 1 pixel unit. The original value is returned before incrementing. The return value can be useful if a function requires the current point before insetting occurs.	
Example	<pre>var n; gfx_MoveTo(20,20); n := 96; while (n--) gfx_ObjectColour(n/3); gfx_LineRel(20, 0); gfx_IncY(); wend</pre> <p>This example draws a simple horizontal gradient using lines.</p>	

2.6.23. gfx_LineTo(xpos, ypos)

Syntax	<code>gfx_LineTo(xpos, ypos);</code>	
Arguments	xpos, ypos	
	xpos	specifies the horizontal position of the line end as well as the new origin.
	ypos	specifies the vertical position of the line end as well as the new origin.
	The arguments can be a variable, array element, expression or constant	
Returns	nothing	
Description	Draws a line from the current origin to a new position. The Origin is then set to the new position. The line is drawn using the current object colour. The line may be tessellated with the <code>gfx_LinePattern(...)</code> function.	
Example	<pre>gfx_MoveTo(10, 20); gfx_LineTo(60, 70);</pre> <p>This example draws a line using the current object colour between x1=10,y1=20 and x2=60,y2=70. The new origin is now set at x=60,y=70.</p>	

2.6.24. gfx_LineRel(xpos, ypos)

Syntax	<code>gfx_LineRel(xpos, ypos);</code>	
Arguments	<code>xpos, ypos</code>	
	<code>xpos</code>	specifies the horizontal end point of the line.
	<code>ypos</code>	specifies the vertical end point of the line.
	The arguments can be a variable, array element, expression or constant	
Returns	<code>nothing</code>	
Description	Draws a line from the current origin to a new position. The line is drawn using the current object colour. The current origin is not altered. The line may be tessellated with the <code>gfx_LinePattern(...)</code> function.	
Example	<pre>gfx_LinePattern(0b1100110011001100); gfx_MoveTo(10, 20); gfx_LineRel(50, 50);</pre> <p>This example draws a tessellated line using the current object colour between 10,20 and 50,50. Note: that <code>gfx_LinePattern(0);</code> must be used after this to return line drawing to normal solid lines.</p>	

2.6.25. gfx_BoxTo(x2, y2)

Syntax	<code>gfx_BoxTo(x2, y2);</code>	
Arguments	<code>x2, y2</code>	
	<code>x2,y2</code>	specifies the diagonally opposed corner of the rectangle to be drawn, the top left corner (assumed to be x1, y1) is anchored by the current origin.
	The arguments can be a variable, array element, expression or constant	
Returns	nothing	
Description	<p>Draws a rectangle from the current origin to the new point using the current object colour. The top left corner is anchored by the current origin (x1, y1), the bottom right corner is specified by x2, y2.</p> <p>Note: The default PEN_SIZE is set to OUTLINE, however, if PEN_SIZE is set to SOLID, the rectangle will be drawn filled, if PEN_SIZE is set to OUTLINE, the rectangle will be drawn as an outline. If the circle is drawn as SOLID, the outline colour can be specified with <code>gfx_OutlineColour(...)</code>. If OUTLINE_COLOUR is set to 0, no outline is drawn.</p>	
Example	<pre>gfx_MoveTo(40,40); n := 10; while (n--) gfx_BoxTo(50,50); gfx_BoxTo(30,30); wend</pre> <p>This example draws 2 boxes, anchored from the current origin.</p>	

2.6.26. gfx_SetClipRegion()

Syntax	<code>gfx_SetClipRegion();</code>
Arguments	none
Returns	nothing
Description	Forces the clip region to the extent of the last text that was printed, or the last image that was shown.
Example	

2.6.27. gfx_Ellipse(x, y, xrad, yrad, colour)

Syntax	<code>gfx_Ellipse(x, y, xrad, yrad, colour);</code>	
Arguments	<code>x, y, xrad, yrad, colour</code>	
	x, y	specifies the horizontal and vertical position of the centre of ellipse
	xrad, yrad	Specifies x-radius and y-radius of the ellipse.
	colour	Specifies the colour for the lines
	The arguments can be a variable, array element, expression or constant	
Returns	nothing	
Description	Plots a coloured Ellipse on the screen at centre x,y with xradius = xrad and yradius = yrad. if PenSize = 0 Ellipse is Solid if PenSize = 1 Ellipse is Outline	
Example	<code>gfx_Ellipse(200, 80, 5, 10, YELLOW);</code>	

2.6.28. gfx_EllipseFilled(x, y, xrad, yrad, colour)

Syntax	<code>gfx_EllipseFilled(x, y, xrad, yrad, colour);</code>	
Arguments	<code>x, y, xrad, yrad, colour</code>	
	x, y	specifies the horizontal and vertical position of the centre of ellipse
	xrad, yrad	Specifies x-radius and y-radius of the ellipse.
	colour	Specifies the colour for the lines
	The arguments can be a variable, array element, expression or constant	
Returns	nothing	
Description	Plots a solid coloured Ellipse on the screen at centre x,y with xradius = xrad and yradius = yrad.	
Example	<code>gfx_EllipseFilled(200,110,10,5, GREEN) ;</code>	

2.6.29. gfx_Button(state, x, y, buttonColour, txtColour, font, txtWidth txtHeight, text)

Syntax	<code>gfx_Button(state, x, y, buttonColour, txtColour, font, txtWidth, txtHeight, text);</code>	
Arguments	<code>state, x, y, buttonColour, txtColour, font, txtWidth, txtHeight, text</code>	
	state	0 = Button depressed; 1 = Button raised.
	x, y	Specifies the top left corner position of the button on the screen.
	buttonColour	Button colour
	txtColour	Text Colour
	font	Specifies the Font ID.
	txtWidth	specifies the width of the text. This value is the font width multiplier and minimum value must be 1.
	txtHeight	specifies the height of the text. This value is the font height multiplier and minimum value must be 1.
	text	Specifies the text string. The text string must be within the range of printable ascii character set. The string may have \n characters embedded to create a multiline button.
Returns	nothing	
Description	<p>Draws a 3 dimensional Text Button at screen location defined by x, y parameters (top left corner). The size of the button depends on the font, width, height and length of the text. The button can contain multiple lines of text by having the \n character embedded in the string for the end of line marker. In this case, the widest text in the string sets the overall width, and the height of the button is set by the number of text lines. In the case of multiple lines, each line is left justified. If you wish to centre or right justify the text, you will need to prepare the text string according to your requirements.</p>	
Example	<pre>#constant LEFT 30 #constant TOP 150 #constant TEXTWIDTH 2 #constant TEXTHEIGHT 2 //----- func main() // Draw a button as a Text Box (indented) gfx_Button(DOWN, 0, 30, GREEN, WHITE, FONT4, TEXTWIDTH, TEXTHEIGHT, "4DGL-Demo"); touch_Set(TOUCH_ENABLE); repeat // Draw the Push Button (raised) gfx_Button(UP, LEFT, TOP, BLUE, RED, FONT4, TEXTWIDTH, TEXTHEIGHT, " PRESS "); // set touch detect region to that of the push button touch_DetectRegion(LEFT, TOP, gfx_Get(RIGHT_POS), gfx_Get(BOTTOM_POS)); // Wait until the button is pressed</pre>	

```
        while(touch_Get(TOUCH_STATUS) != TOUCH_PRESS);  
        // now redraw the Push Button (depressed)  
        gfx_Button(DOWN, LEFT, TOP, BLUE, WHITE, FONT4, TEXTWIDTH,  
        TEXTHEIGHT, " PRESS ");  
        // Wait until the button is pressed  
        while(touch_Get(TOUCH_STATUS) != TOUCH_RELEASE);  
    forever  
endfunc
```

2.6.30. gfx_Panel(state, x, y, Width, Height, Colour)

Syntax	<code>gfx_Panel(state, x, y, Width, Height, Colour);</code>	
Arguments	<code>state, x, y, buttonColour, txtColour, font, txtWidth, txtHeight, text</code>	
	state	0 = recessed; 1 = raised.
	x, y	Specifies the top left corner position of the panel on the screen.
	Width	specifies the width of the panel.
	Height	Specifies the Height of the panel.
	Colour	Specifies the colour of the panel.
Returns	nothing	
Description	Draws a 3 dimensional rectangular panel at a screen location defined by x, y parameters (top left corner). The size of the panel is set with the width and height parameters. The colour is defined by colour The state parameter determines the appearance of the panel, 0 = recessed, 1 = raised.	
Example	<pre>#constant LEFT 15 #constant TOP 15 #constant WIDTH 100 #constant HEIGHT 100 func main() // Draw a panel gfx_Panel(RAISED, LEFT, TOP, WIDTH, HEIGHT, GRAY); repeat forever endfunc</pre>	

2.6.31. gfx_Slider(mode, x1, y1, x2, y2, colour, scale, value)

Syntax	<code>gfx_Slider(mode, x1, y1, x2, y2, colour, scale, value);</code>	
Arguments	mode, x1, y1, x2, y2, colour, scale, value	
	mode	mode = 0 : Slider Indented, mode = 1 : Slider Raised, mode 2, Slider Hidden (background colour).
	x1, y1	specifies the top left corner position of the slider on the screen.
	x2, y2	specifies the bottom right corner position of the slider on the screen.
	colour	specifies the colour of the Slider bar.
	Scale	scale = n : sets the full scale range of the slider for the thumb from 0 to n.
	Value	if value positive, sets the relative position of the thumb on the slider bar, else set thumb to ABS position of the negative number.
Returns	<p>If the value parameter was a positive number (i.e:- value is a proportion of the scale parameter) , the true (implied x or y axis) position of the thumb is returned.</p> <p>If the value parameter was a negative number (i.e:- thumb is being set to an ABSolute graphics position) , the actual slider value (which is a proportion of the scale parameter) is returned.</p>	
Description	<p>Draws a vertical or horizontal slider bar on the screen. The gfx_Slider function has several different modes of operation. In order to minimise the amount of graphics functions we need, all modes of operation are selected naturally depending on the parameter values.</p> <p>Selection rules:</p> <p>1a] if $x_2 - x_1 > y_2 - y_1$ slider is assumed to be horizontal (ie: if width > height, slider is horizontal)</p> <p>1b] if $x_2 - x_1 \leq y_2 - y_1$ slider is assumed to be vertical (ie: if height \leq width, slider is horizontal)</p> <p>2a] If value is positive, thumb is set to the position that is the proportion of value to the scale parameter.(used to set the control to the actual value of a variable)</p> <p>2b] If value is negative, thumb is driven to the graphics position set by the ABSolute of value value. (used to set thumb to its actual graphical position (usually by touch screen)</p> <p>3] The thumb colour is determine by <code>gfx_Set(OBJECT_COLOUR, value);</code> , however, if the current object colour is BLACK, a darkened shade of the colour parameter is used for the thumb .</p>	
	<pre>func drawRedSlider () gfx_Slider(0,rSlider[0],rSlider[1],rSlider[2],rSlider[3],RED,255, valR); txt_MoveCursor(1,12); txt_Set(TEXT_OPACITY, OPAQUE); txt_Set(TEXT_COLOUR, RED); print (" "); txt_MoveCursor(1,12); print ([DEC] valR); endfunc</pre>	

2.6.32. `gfx_ScreenCopyPaste(xs, ys, xd, yd, width, height)`

Syntax	<code>gfx_ScreenCopyPaste(xs, ys, xd, yd, width, height);</code>	
Arguments	<code>xs, ys, xd, yd, width, height</code>	
	xs, ys	Specifies the horizontal and vertical position of the top left corner of the area to be copied (source).
	xd, yd	Specifies the horizontal and vertical position of the top left corner of where the paste is to be made (destination).
	width	Specifies the width of the copied area.
	height	Specifies the height of the copied area.
	The arguments can be a variable, array element, expression or constant	
Returns	<code>nothing</code>	
Description	Copies an area of a screen from <code>xs, ys</code> of size given by <code>width</code> and <code>height</code> parameters and pastes it to another location determined by <code>xd, yd</code> .	

2.6.33. gfx_RGBto565(RED, GREEN, BLUE)

Syntax	gfx_RGBto565(RED, GREEN, BLUE);	
Arguments	RED, GREEN, BLUE	
	RED	8bit colour value for RED.
	GREEN	8bit colour value for GREEN. .
	BLUE	8bit colour value for BLUE.
	The arguments can be a variable, array element, expression or constant	
Returns	Returns the 16bit (RED:5, GREEN:6, BLUE:5 format) colour value.	
Description	Returns the 16bit (RED:5, GREEN:6, BLUE:5 format) colour value of a 24bit (RED:8, GREEN:8, BLUE:8 format) colour.	

2.6.34. gfx_332to565(COLOUR)

Syntax	gfx_332to565(COLOUR);	
Arguments	Colour	
	Colour	8bit colour value. 3bits for RED, 3bits for GREEN, 2bits for BLUE.
Returns	Returns the 16bit (RED:5, GREEN:6, BLUE:5 format) value	
Description	Returns the 16bit (RED:5, GREEN:6, BLUE:5 format) value of an 8bit (RED:3, GREEN:3, BLUE:2 format) colour	

2.6.35. gfx_Selection(index, backColour, textColour)

Syntax	<code>gfx_Selection(index, backColour, textColour);</code>	
Arguments	<code>index, backColour, textColour</code>	
	index	0 = No Selection; 1 to n = Selected line to be highlighted..
	backColour	specifies the colour of the text background.
	textColour	specifies the colour of the text.
	The arguments can be a variable, array element, expression or constant	
Returns	<code>nothing</code>	
Description	<p>Called prior to drawing a text button with <code>gfx_Button</code>, this function will highlight a text line of a single or multi-line button. The required line is defined by <code>index</code>, and the line will be highlighted with the desired <code>backColour</code> and <code>textColour</code> parameters. If the <code>index</code> is 0, no line will be highlighted, in the case of a single line button, the <code>index</code> can only be 1. In the case of a multi-line button, the <code>index</code> corresponds to the line you wish to highlight. This allows you to form the basic component for a listbox.</p> <p><code>gfx_Selection</code> is persistent i.e it does not auto-disabled once the button is drawn, so you must disable it when not required by issuing <code>gfx_Selection(0,0,0)</code>;</p> <p>The default condition is no selection.</p> <p>Note that on platforms with no display buffering, some flicker may be experienced when drawing multiline buttons.</p>	
Example	<pre>func main() // Draw a button as a List Box (sunken) gfx_Selection(3, RED, YELLOW); // pre-select "Item3" gfx_Button(DOWN, 30, 30, GREEN, WHITE, FONT4, 1, 1, "Item1\nItem2\nItem3\nItem4"); repeat forever endfunc</pre>	

2.6.36. `gfx_TriangleFilled(x1, y1, x2, y2, x3, y3, colour)`

Syntax	<code>gfx_TriangleFilled(x1, y1, x2, y2, x3, y3, colour);</code>	
Arguments	<code>x1, y1, x2, y2, x3, y3, colour</code>	
	<code>x1, y1</code>	specifies the first vertices of the triangle.
	<code>x2, y2</code>	specifies the second vertices of the triangle.
	<code>x3, y3</code>	specifies the third vertices of the triangle.
	<code>colour</code>	Specifies the colour for the triangle.
	The arguments can be a variable, array element, expression or constant	
Returns	<code>nothing</code>	
Description	Draws a Solid triangle between vertices <code>x1,y1</code> , <code>x2,y2</code> and <code>x3,y3</code> using the specified colour. Vertices must be specified in an anti-clockwise fashion.	
Example	<pre>gfx_TriangleFilled(10,10,30,10,20,30,CYAN);</pre> <p>This example draws a CYAN Solid triangle with vertices at 10,10 30,10 20,30</p>	

2.6.37. gfx_PolygonFilled(n, vx, vy, colour)

Syntax	<code>gfx_PolygonFilled(n, vx, vy, colour);</code>	
Arguments	n, vx, vy, colour	
	n	specifies the number of elements in the x and y arrays specifying the vertices for the polygon.
	vx	specifies the addresses of the storage of the array of elements for the x coordinates of the vertices.
	vy	specifies the addresses of the storage of the array of elements for the y coordinates of the vertices.
	colour	Specifies the colour for the polygon
	The arguments can be a variable, array element, expression or constant	
Returns	nothing	
Description	Draws a solid Polygon between specified vertices: x1,y1 x2,y2 .. xn,yn using the specified colour. The last point is drawn back to the first point, completing the polygon. Vertices must be minimum of 3 and can be specified in any fashion	
Example	<pre> var vx[7], vy[7]; func main() vx[0] := 10; vy[0] := 10; vx[1] := 35; vy[1] := 5; vx[2] := 80; vy[2] := 10; vx[3] := 60; vy[3] := 25; vx[4] := 80; vy[4] := 40; vx[5] := 35; vy[5] := 50; vx[6] := 10; vy[6] := 40; gfx_PolygonFilled(7, vx, vy, RED); repeat forever endfunc </pre> <p>This example draws a simple filled polygon</p>	

2.6.38. gfx_Origin(x, y)

Syntax	<code>gfx_Origin(x, y);</code>	
Arguments	<code>x, y</code>	
	<code>x, y</code>	specifies the horizontal and vertical position of the top left corner of the clipping window.
Returns	nothing	
Description	Sets relative screen offset for horizontal and vertical for the top left corner for graphics objects.	
Example	<code>gfx_Offset (arg1, arg2);</code>	

2.6.39. gfx_Get(mode)

Syntax	<code>gfx_Get(mode);</code>	
Arguments	mode	
	mode	<p>mode = 0 : Current orientations Max X Value (X_MAX) mode = 1 : Current orientations Max Y Value (Y_MAX) mode = 2 : Left location of Object mode = 3 : Top location of Object mode = 4 : Right location of Object mode = 5 : Bottom location of Object mode = 6 : Get current internal X position mode = 7 : Get current internal Y position</p>
Returns	<p>Mode0 Returns the maximum horizontal value of the display.</p> <p>Mode1 Returns the maximum vertical value of the display.</p> <p>Mode2 Returns the left location of the last drawn object such as a slider or button or an image/video.</p> <p>Mode3 Returns the top location of the last drawn object such as a slider or button or an image/video.</p> <p>Mode4 Returns the right location of the last drawn object such as a slider or button or an image/video.</p> <p>Mode5 Returns the bottom location of the last drawn object such as a slider or button or an image/video.</p> <p>Mode6 Returns the internal X position that was set with MoveTo(x, y); or gfx_Set(X_ORG, pos);</p> <p>Mode7 Returns the internal Y position that was set with MoveTo(x, y); or gfx_Set(X_ORG, pos);</p>	
Description	Returns various graphics parameters to caller.	
Example	<pre>var := gfx_Get(X_MAX); //Returns the maximum horizontal resolution of the display var := gfx_Get(0); var := gfx_Get(Y_MAX); //Returns the maximum vertical resolution of the display var := gfx_Get(1); var := gfx_Get(RIGHT_POS); //Returns the right location of the last drawn object //that only has top, left parameters such as a button // or an image/video. var := gfx_Get(2); var := gfx_Get(BOTTOM_POS); //Returns the bottom location of the last drawn object //that only has top, left parameters such as a button //or an image/video. var := gfx_Get(3);</pre>	

2.6.40. gfx_ClipWindow(x1, y1, x2, y2)

Syntax	<code>gfx_ClipWindow(x1, y1, x2, y2);</code>	
Arguments	<code>x1, y1, x2, y2</code>	
	x1, y1	specifies the horizontal and vertical position of the top left corner of the clipping window.
	x2, y2	specifies the horizontal and vertical position of the bottom right corner of the clipping window.
	The arguments can be a variable, array element, expression or constant	
Returns	nothing	
Description	Specifies a clipping window region on the screen such that any objects and text placed onto the screen will be clipped and displayed only within that region. For the clipping window to take effect, "Clipping" setting must be enabled separately using <code>gfx_Set(CLIPPING, ON)</code> or the shortcut <code>gfx_Clippping(ON)</code> .	
Example	<pre>var n; gfx_ClipWindow(10, 10, 50, 50) n := 50000; while (n--) gfx_PutPixel (RAND() %100, RAND() %100, RAND()); wend repeat forever</pre> <p>This example will draw 50000 random colour pixels, only the pixels within the clipping area will be visible</p>	

2.6.41. gfx_Set(function, value)

Syntax	<code>gfx_Set(function, value);</code>	
Arguments	function, value	
	function	The function number determines the required action for various graphics control functions. Usually a constant, but can be a variable, array element, or expression. There are pre-defined constants for each of the functions.
	value	A variable, array element, expression or constant holding a value for the selected function.
Returns	nothing	
Description	Given a function number and a value, set the required graphics control parameter, such as size, colour, and other parameters. (see the Single parameter short-cuts for the gfx_Set functions below).	
	function	value
Predefined Name	Description	
PEN_SIZE	Set the draw mode for <code>gfx_LineTo</code> , <code>gfx_LineRel</code> , <code>gfx_Dot</code> , <code>gfx_Bullet</code> and <code>gfx_BoxTo</code> (default mode is OUTLINE) nb:- pen size is set to OUTLINE for normal operation	0 or SOLID 1 or OUTLINE
BACKGROUND_COLOUR	Set the screen background colour	Colour, 0-65535
OBJECT_COLOUR	Generic colour for <code>gfx_LineTo(...)</code> , <code>gfx_LineRel(...)</code> , <code>gfx_Dot()</code> , <code>gfx_Bullet(...)</code> and <code>gfx_BoxTo(...)</code>	Colour, 0-65535
CLIPPING	Turns clipping on/off. The clipping points are set with <code>gfx_ClipWindow(...)</code>	1 or 0 (ON or OFF)
TRANSPARENT_COLOUR	Colour that needs to be made transparent.	Colour, 0-65535
TRANSPARENCY	Turn the transparency ON or OFF.	1 or 0 (ON or OFF)
FRAME_DELAY	Set the inter frame delay for <code>media_Video(...)</code>	0 to 255msec
SCREEN_MODE	Set required screen behaviour/orientation. Note: Does not apply to uVGA-II(GFX) module.	1 or LANDSCAPE 2 or LANDSCAPE_R 3 or PORTRAIT 4 or PORTRAIT_R
OUTLINE_COLOUR	Outline colour for rectangles and circles (set to 0 for no effect)	Colour, 0-65535
CONTRAST	OLED MODULES: Set contrast value, 0 = display off, 1-9 = contrast level LCD MODULES: contrast 0 = display OFF, non zero = display ON) EXCEPTION: uLCD-43(GFX) supports Contrast values from 1-9 and 0 to turn the Display off. Note: Does not apply to uVGA-II(GFX) module.	0 or OFF 1 to 9 for levels 1 or 0 (ON or OFF)
BEVEL_WIDTH	Set Button Bevel Width, 0 pixel to 15pixels.	0 None 1 to 15 pixels

SCREEN_RES	Set VGA Screen resolution. Applies to uVGA-II(GFX) and uLCD-43(GFX) only.	0 for 320x240 1 for 640 x 480 2 for 800 x 480
DISPLAY_PAGE	Choose Page to be displayed. Value depends on the resolution set. Applies to uVGA-II(GFX) and uLCD-43(GFX) only.	e.g. 00hex-04hex for 320x240 resolution on a uVGA-II(GFX).
READ_PAGE	Choose the Page to be read. Value depends on the resolution set. Applies to uVGA-II(GFX) and uLCD-43(GFX) only.	e.g. 00hex-04hex for 320x240 resolution on a uVGA-II(GFX).
WRITE_PAGE	Choose the Page to be written. Value depends on the resolution set. Applies to uVGA-II(GFX) and uLCD-43(GFX) only.	e.g. 00hex-04hex for 320x240 resolution on a uVGA-II(GFX).

Single parameter short-cuts for the gfx_Set(..) functions

Function Syntax	Function Action	value
gfx_PenSize(mode)	Set the draw mode for gfx_LineTo, gfx_LineRel, gfx_Dot, gfx_Bullet and gfx_BoxTo Note: pen size is set to OUTLINE for normal operation (default).	0 or SOLID 1 or OUTLINE
gfx_BGcolour(colour)	Set the screen background colour	Colour 0-65535
gfx_ObjectColour(colour)	Generic colour for gfx_LineTo(...), gfx_LineRel(...), gfx_Dot(), gfx_Bullet(... and gfx_BoxTo	Colour 0-65535
gfx_Clipping(mode)	Turns clipping on/off. The clipping points are set with gfx_ClipWindow(...)	0 or 1 (ON or OFF)
gfx_TransparentColour(colour)	Colour that needs to be made transparent.	Colour, 0-65535
gfx_Transparency(mode)	Turn the transparency ON or OFF.	1 or 0 (ON or OFF)
gfx_FrameDelay(delay)	Set the inter frame delay for media_Video(...)	0 to 255msec
gfx_ScreenMode(mode)	Graphics orientation LANDSCAPE, LANDSCAPE_R, PORTRAIT, PORTRAIT_R Note: Does not apply to uVGA-II(GFX) module.	1 or LANDSCAPE 2 or LANDSCAPE_R 3 or PORTRAIT 4 or PORTRAIT_R
gfx_OutlineColour(colour)	Outline colour for rectangles and circles. (set to 0 for no effect)	Colour 0-65535
gfx_Contrast(value)	OLED MODULES: Set contrast value, 0 = display off, 1-9 = contrast level LCD MODULES: contrast 0 = display OFF, non zero = display ON) EXCEPTION: uLCD-43(GFX) supports Contrast values from 1-9 and 0 to turn the Display off. Note: Does not apply to uVGA-II(GFX) module.	0 or OFF 1 to 9 for levels 1 or 0 (ON or OFF)
gfx_LinePattern(pattern)	Sets the line draw pattern for line drawing. If set to zero, lines are solid, else each '1' bit represents a pixel that is turned off. See code examples for further reference.	0 bits for pixels on 1 bits for pixels off
gfx_ColourMode(mode)	Sets 8 or 16bit colour mode Function not available, fixed as 16bit mode.	0 or COLOUR16 1 or COLOUR8
gfx_BevelWidth(mode)	graphics button bevel width	0 None 1 to 15 pixels
gfx_BevelShadow(value)	graphics button bevel shadow depth	

gfx_Xorigin(offset)	graphics X origin	
gfx_Yorigin(offset)	graphics Y origin	

2.7. Display I/O Functions

These functions allow direct display access for fast blitting operations.

Summary of Functions in this section:

- `disp_SetReg(register, data)`
- `disp_setGRAM(x1, y1, x2, y2)`
- `disp_WrGRAM(colour)`
- `disp_WriteControl(value)`
- `disp_WriteWord(value)`
- `disp_ReadWord()`
- `disp_Sync(line)`

2.7.1. disp_SetReg(register, data)

Syntax	<code>disp_SetReg(register, data);</code>	
Arguments	<code>register, data</code>	
	<code>register</code>	Refer to the display driver data sheet
	<code>data</code>	Refer to the display driver data sheet
Returns	<code>nothing</code>	
Description	Sets the Display driver IC register.	

2.7.2. disp_setGRAM(x1, y1, x2, y2)

Syntax	<code>disp_setGRAM(x1, y1, x2, y2);</code>	
Arguments	<code>x1, y1, x2, y2</code>	
	<code>x1, y1</code>	Top left of the GRAM window.
	<code>x2, y2</code>	Bottom right of the GRAM window.
Returns	the LO word of the 32 bit pixel count is returned	
Description	Prepares the GRAM area for user access. The lower 16bits of the pixel count in the selected area is returned This is usually all that is needed unles GRAM area exceeds 256^2. A copy of the 32bit value can be found in GRAM_PIXEL_COUNT_LO and GRAM_PIXEL_COUNT_HI.	

2.7.3. disp_WrGRAM(colour)

Syntax	<code>disp_WrGRAM(colour);</code>	
Arguments	<code>colour</code>	
	<code>colour</code>	Pixel color to be populated.
Returns	<code>nothing</code>	
Description	Data can be written to the GRAM consecutively using this function once the GRAM access window has been setup.	

2.7.4. disp_WriteControl(value)

Syntax	<code>disp_WriteControl(value);</code>	
Arguments	value	
	value	Specifies the 16 bit value to be written to the display control register.
	The arguments can be a variable, array element, expression or constant	
Returns	nothing	
Description	Sends a 16 bit value to the display bus. Refer to individual data sheets for the display for more information. This function is used to extend the capabilities of the user code to gain access to the the display hardware.	

2.7.5. disp_WriteWord(value)

Syntax	<code>disp_WriteWord(value);</code>	
Arguments	value	
	value	Specifies the value to be written to the display data register.
	The arguments can be a variable, array element, expression or constant	
Returns	nothing	
Description	Sends a 16 bit value to the display bus. Refer to individual data sheets for the display for more information. This function is used to extend the capabilities of the user code to gain access to the the display hardware.	

2.7.6. disp_ReadWord(value)

Syntax	<code>disp_ReadWord(value);</code>	
Arguments	value	
	value	Specifies the value to be read from the display data register.
Returns	Returns 16 bit value in the register.	
Description	Read a word from the display.	

2.7.7. disp_Sync(line)

Syntax	disp_Sync(line);	
Arguments	line	
	line	Scan line.
Returns	Returns 16 bit value in the register.	
Description	<p>Allows the program to synchronise writing to the hardware for flicker free operation. Some experimentation may be needed to find an optimum line for disp_Sync depending on the graphics operation. The higher the value, the slower the throughput. A certain point will be reached (number of scanlines + blanking lines within the vertical retrace period) where it will just 'hang up' stopping the entire process. Eg, in 640x480 mode, if the 'lines' value is 507, operation will be slowest (as its actually right at the end of the blanking period) and 508 will cause a hangup situation as it is above the highest scanline value.</p> <p>Note: Applies to uVGA-II(GFX) module only.</p>	

2.8. Media Functions (SD/SDHC Memory Card or Serial Flash chip)

The media can be SD/SDHC, microSD or serial (NAND) flash device interfaced to the PICASO-GFX2 SPI port.

Summary of Functions in this section:

- `media_Init()`
- `media_SetAdd(HIword, LOword)`
- `media_SetSector(HIword, LOword)`
- `media_RdSector(Destination_Address)`
- `media_WrSector(Source_Address)`
- `media_ReadByte()`
- `media_ReadWord()`
- `media_WriteByte(byte_val)`
- `media_WriteWord(word_val)`
- `media_Flush()`
- `media_Image(x, y)`
- `media_Video(x, y)`
- `media_VideoFrame(x, y, frameNumber)`

2.8.1. media_Init()

Syntax	<code>media_Init();</code>	
Arguments	none	
Returns	result	
	result	Returns: 1 if memory card is present and successfully initialised Returns: 0 if no card is present or not able to initialise
Description	Initialise a uSD/SD/SDHC memory card for further operations. The SD card is connected to the SPI (serial peripheral interface) of the PICASO-GFX2 chip.	
Example	<pre>while(!media_Init()) gfx_Cls(); pause(300); puts("Please insert SD card"); pause(300); wend</pre> <p>This example waits for SD card to be inserted and initialised, flashing a message if no SD card detected.</p>	

2.8.2. media_SetAdd(HIword, LOword)

Syntax	<code>media_SetAdd(HIword, LOword);</code>	
Arguments	HIword, LOword	
	HIword	specifies the high word (upper 2 bytes) of a 4 byte media memory byte address location.
	LOword	specifies the low word (lower 2 bytes) of a 4 byte media memory byte address location.
	The arguments can be a variable, array element, expression or constant	
Returns	nothing	
Description	Set media memory internal Address pointer for access at a non sector aligned byte address.	
Example	<pre>media_SetAdd(0, 513);</pre> <p>This example sets the media address to byte 513 (which is sector #1, 2nd byte in sector) for subsequent operations.</p>	

2.8.3. media_SetSector(HIword, LOword)

Syntax	<code>media_SetSector(HIword, LOword);</code>	
Arguments	HIword, LOword	
	HIword	specifies the high word (upper 2 bytes) of a 4 byte media memory sector address location.
	LOword	specifies the low word (lower 2 bytes) of a 4 byte media memory sector address location.
	The arguments can be a variable, array element, expression or constant	
Returns	result	
Description	Set media memory internal Address pointer for sector access.	
Example	<pre>media_SetSector(0, 10);</pre> <p>This example sets the media address to the 11th sector (which is also byte address 5120) for subsequent operations</p>	

2.8.4. media_RdSector(Destination_Address)

Syntax	<code>media_RdSector(Destination_Address);</code>	
Arguments	Destination_Address	
	Destination_Address	Destination block pointed to by the internal Sector pointer. The argument must be a pointer to an array of size 256 words for the sector data which will be 512 bytes
Returns	Returns TRUE if media response was TRUE. Returns 512 bytes (256 words) in to a destination block.	
Description	Reads and Returns 512 bytes (256 words) into a destination block (eg <code>rdblock[256]</code>) pointed to by the internal Sector pointer. After the read the Sector pointer is automatically incremented by 1.	
Example	<pre>var rdblock[256]; media_SetSector(0,10) if (media_RdSector(rdblock)); Print("Data collected"); endif</pre> <p>This example sets a 512 bytes block and collects data from the address pointed to by <code>media_SetSector</code> command.</p>	

2.8.5. media_WrSector(Source_Address)

Syntax	<code>media_WrSector(Source_Address);</code>	
Arguments	Source_Address	
	Source_Address	Source memory block of 512bytes.
	The arguments can be a variable, array element, expression or constant	
Returns	Returns TRUE if media response was TRUE.	
Description	Writes 512 bytes (256 words) from a source memory block (eg wrblock[256]) into the uSD card. After the write the Sect pointer is automatically incremented by 1. Returns TRUE if uSD response was TRUE	
Example	<pre>var wrblock[256]; func main() prepare_block(); media_SetSector(0,10) if (media_WrSector(wrblock)); Print("Data transferred"); endif : : This example sets a 512 bytes block and transfers data to the address pointed to by media_SetSector command.</pre>	

2.8.6. media_ReadByte()

Syntax	<code>media_ReadByte();</code>
Arguments	none
Returns	byte value
Description	Returns the byte value from the current media address. The internal byte address will then be internally incremented by one.
Example	<pre>var LObyte, HIbyte; if(media_Init()) media_SetAdd(0, 510); LObyte := media_ReadByte(); HIbyte := media_ReadByte(); print([HEX2]HIbyte, [HEX2]LObyte); endif repeat forever</pre> <p>This example initialises the media, sets the media byte address to 510, and reads the last 2 bytes from sector 0. If the card happens to be FAT formatted, the result will be "AA55". The media internal address is internally incremented for each of the byte operations.</p>

2.8.7. media_ReadWord()

Syntax	<code>media_ReadWord();</code>
Arguments	none
Returns	word value
Description	Returns the word value (2 bytes) from the current media address. The internal byte address will then be internally incremented by one. If the address is not aligned, the word will still be read correctly.
Example	<pre>var myword; if(media_Init()) media_SetAdd(0, 510); myword := media_ReadWord(); print([HEX4]myword); endif repeat forever</pre> <p>This example initialises the media, sets the media byte address to 510 and reads the last word from sector 0. If the card happens to be formatted, the result will be "AA55"</p>

2.8.8. media_WriteByte(byte_val)

Syntax	media_WriteByte(byte_val);	
Arguments	byte_val	
	byte_val	The lower 8 bits specifies the byte to be written at the current media address location.
	The arguments can be a variable, array element, expression or constant	
Returns	success	
	success	Returns non zero if write was successful.
Description	Writes a byte to the current media address that was initially set with media_SetSector(...) ; Note: Writing bytes or words to a media sector must start from the beginning of the sector. All writes will be incremental until the media_Flush() function is executed, or the sector address rolls over to the next sector. When media_Flush() is called, any remaining bytes in the sector will be padded with 0xFF , destroying the previous contents. An attempt to use the media_SetAdd(..) function will result in the lower 9 bits being interpreted as zero. If the writing rolls over to the next sector, the media_Flush() function is issued automatically internally.	
Example	<pre> var n, char; while (media_Init()==0); // wait if no SD card detected media_SetSector(0, 2); // at sector 2 //media_SetAdd(0, 1024); // (alternatively, use media_SetAdd(), // lower 9 bits ignored) while (n < 10) media_WriteByte(n++ +'0'); // write ASCII '0123456789' to the wend // first 10 locations. to(MDA); putstr("Hello World"); // now write a ascii test string media_WriteByte('A'); // write a further 3 bytes media_WriteByte('B'); media_WriteByte('C'); media_WriteByte(0); // terminate with zero media_Flush(); // we're finished, close the sector media_SetAdd(0, 1024+5); // set the starting byte address while(char:=media_ReadByte()) putch(char); // print result, starting // from '5' repeat forever </pre> <p>This example initialises the media, writes some bytes to the required sector, then prints the result from the required location.</p>	

2.8.9. media_WriteWord(word_val)

Syntax	<code>media_WriteWord(word_val);</code>	
Arguments	<code>word_val</code>	
	<code>word_val</code>	The 16 bit word to be written at the current media address location.
	The arguments can be a variable, array element, expression or constant	
Returns	<code>success</code>	
	<code>success</code>	Returns non zero if write was successful.
Description	<p>Note: Writing bytes or words to a media sector must start from the beginning of the sector. All writes will be incremental until the <code>media_Flush()</code> function is executed, or the sector address rolls over to the next sector. When <code>media_Flush()</code> is called, any remaining bytes in the sector will be padded with <code>0xFF</code>, destroying the previous contents. An attempt to use the <code>media_SetAdd(..)</code> function will result in the lower 9 bits being interpreted as zero. If the writing rolls over to the next sector, the <code>media_Flush()</code> function is issued automatically internally.</p>	
Example	<pre> var n; while (media_Init()==0); // wait until a good SD card is found n:=0; media_SetAdd(0, 1536); // set the starting byte address while (n++ < 20) media_WriteWord(RAND()); // write 20 random words to first 20 wend // word locations. n:=0; while (n++ < 20) media_WriteWord(n++*1000); // write sequence of 1000*n to next 20 wend // word locations. media_Flush(); // we're finished, close the sector media_SetAdd(0, 1536+40); // set the starting byte address n:=0; while(n++<8) // print result of fist 8 multiplication calcs print([HEX4] media_ReadWord(),"\n"); wend repeat forever // This example initialises the media, writes some words to the required sector, then prints // the result from the required location. </pre>	

2.8.10. media_Flush()

Syntax	<code>media_Flush();</code>
Arguments	none
Returns	returns 0 if Failed returns non-zero if OK
Description	After writing any data to a sector, <code>media_Flush()</code> should be called to ensure that the current sector that is being written is correctly stored back to the media else write operations may be unpredictable.
Example	See the media_WriteByte(..) and media_WriteWord(..) examples.

2.8.11. media_Image(x, y)

Syntax	media_Image(x, y);	
Arguments	x, y	
	x, y	specifies the top left position where the image will be displayed.
	The arguments can be a variable, array element, expression or constant	
Returns	nothing	
Description	Displays an image from the media storage at the specified co-ordinates. The image address is previously specified with the media_SetAdd(..) or media_SetSector(...) function. If the image is shown partially off screen, it may not be displayed correctly.	
Example	<pre>while(media_Init()==0); // wait if no SD card detected media_SetAdd(0x0001, 0xDA00); // point to the books04 image media_Image(10,10); gfx_Clippping(ON); // turn off clipping to see the difference media_Image(-12,50); // show image off-screen to the left media_Image(50,-12); // show image off-screen at the top repeat forever</pre> <p>This example draws an image at several positions, showing the effects of clipping.</p>	

2.8.12. `media_Video(x, y)`

Syntax	<code>media_Video(x, y);</code>
Arguments	<code>x, y</code>
	<code>x, y</code> specifies the top left position where the video clip will be displayed. The arguments can be a variable, array element, expression or constant
Returns	nothing
Description	Displays a <i>video</i> clip from the media storage device at the specified co-ordinates. The <i>video</i> address location in the media is previously specified with the media_SetAdd(..) or media_SetSector(...) function. If the <i>video</i> is shown partially off screen, it may not be displayed correctly. Note that showing a <i>video</i> blocks all other processes until the video has finished showing. See the media_VideoFrame(...) functions for alternatives.
Example	<pre>while(media_Init()==0); // wait if no SD card detected media_SetAdd(0x0001, 0x3C00); // point to the 10-gear clip media_Video(10,10); gfx_Clipping(ON); // turn off clipping to see the difference media_Video(-12,50); // show video off-screen to the left media_Video(50,-12); // show video off-screen at the top repeat forever</pre> <p>This example plays a video clip at several positions, showing the effects of clipping.</p>

2.8.13. media_VideoFrame(x, y, frameNumber)

Syntax	media_VideoFrame(x, y, frameNumber);	
Arguments	x, y	
	x, y	specifies the top left position where the video clip will be displayed.
	frameNumber	Specifies the required frame to be shown.
	The arguments can be a variable, array element, expression or constant	
Returns	nothing	
Description	<p>Displays a <i>video</i> from the media storage device at the specified co-ordinates. The <i>video</i> address is previously specified with the media_SetAdd(..) or media_SetSector(...) function. If the <i>video</i> is shown partially off it may not be displayed correctly. The frames can be shown in any order. This function gives you great flexibility for showing various icons from an image strip, as well as showing videos while doing other tasks</p> <p>media_VideoFrame(..) will now show error box for out of range video frames. Also, if frame is set to -1, just a rectangle will be drawn in background colour to blank an image. It applies to PmmC R29 or above.</p>	
Example	<pre>var frame; while (media_Init()==0); // wait if no SD card detected while (media_Init()==0); // wait if no SD card detected media_SetAdd(0x0002, 0x3C00); // point to the 10-gear image repeat frame := 0; // start at frame 0 repeat media_VideoFrame(30,30, frame++); // display a frame pause(peekB(IMAGE_DELAY)); // pause for the time given in // the image header until(frame == peekW(IMG_FRAME_COUNT)); // loop until we've // shown all the frames forever // do it forever</pre> <p>This first example shows how to display frames as required while possibly doing other tasks. Note that the frame timing (although not noticeable in this small example) is not correct as the delay commences after the image frame is shown, therefore adding the display overheads to the frame delay. This second example employs a timer for the framing delay, and shows the same movie simultaneously running forward and backwards with time left for other tasks as well. A number of videos (or animated icons) can be shown simultaneously using this method.</p> <pre>var framecount, frame, delay, colr; frame := 0; // show the first frame so we can get the video header info // into the system variables, and then to our local variables. media_VideoFrame(30,30, 0); framecount := peekW(IMG_FRAME_COUNT); // we can now set some local // values. delay := peekB(IMAGE_DELAY); // get the frame count and delay repeat repeat pokeW(TIMER0, delay); // set a timer</pre>	

```
media_VideoFrame(30,30, frame++); // show next frame
gfx_MoveTo(64,35);
print([DEC2Z] frame);           // print the frame number
media_VideoFrame(30,80, framecount-frame); // show movie
// backwards.
gfx_MoveTo(64,85);
print([DEC2Z] framecount-frame); // print the frame number

if ((frame & 3) == 0)
    gfx_CircleFilled(80,20,2,colr); // a blinking circle fun
    colr := colr ^ 0xF800; // alternate colour,
endif // BLACK/RED using XOR
// do more here if required
while(peekW(TIMER0)); // wait for timer to expire
until(frame == peekW(IMG_FRAME_COUNT));
frame := 0;
forever
```

2.9. Flash Memory Chip Functions

The functions in this section only apply to serial SPI (NAND) flash devices interfaced to the PICASO-GFX2 SPI port.

Summary of Functions in this section:

- flash_SIG()
- flash_ID()
- flash_BulkErase()
- flash_BlockErase(blockAddress)

2.9.1. flash_SIG()

Syntax	flash_SIG();	
Arguments	none	
Returns	signature	
	signature	Release from Deep Power-down, and Read Electronic Signature. Only the low order byte is valid, the upper byte is ignored.
Description	If a FLASH storage device is connected to the SPI port, and has been correctly initialised with the spi_Init(...) function, the Electronic Signature of the device can be read using this function. The only devices supported so far on the PICASO-GFX2 are the M25Pxx range of devices which are 512Kbit to 32Mbit (2M x 8) Serial Flash Memory.	

2.9.2. flash_ID()

Syntax	flash_ID();	
Arguments	none	
Returns	type_capacity	
	type_capacity	Reads the memory type and capacity from the serial FLASH device. Hi byte contains type, and low byte contains capacity. Refer to the device data sheet for further information.
Description	If a FLASH storage device is connected to the SPI port, and has been correctly initialised with the spi_Init(...) function, the memory type and capacity from the flash device can be read using this function. The only devices supported so far on the PICASO-GFX2 are the M25Pxx range of devices which are 512Kbit to 32Mbit (2M x 8) Serial Flash Memory.	

2.9.3. flash_BulkErase()

Syntax	<code>flash_BulkErase();</code>
Arguments	none
Returns	nothing
	Erases the entire flash media device. The function returns no value, and the operation can take up to 80 seconds depending on the size of the flash device.
Description	If a FLASH storage device is connected to the SPI port, and has been correctly initialised with the spi_Init(...) function, the FLASH device can be completely erased using this function. The only devices supported so far on the PICASO-GFX2 are the M25Pxx range of devices which are 512Kbit to 32Mbit (2M x 8) Serial Flash Memory.

2.9.4. flash_BlockErase(blockAddress)

Syntax	flash_BlockErase(blockAddress);	
Arguments	blockAddress	
	blockAddress	The address of the 64k FLASH block to be erased.
Returns	result	
	result	Erases the required block in a FLASH media device. The function returns no value, and the operation can take up to 3 milliseconds.
Description	<p>If a FLASH storage device is connected to the SPI port, and has been correctly initialised with the spi_Init(...) function, the FLASH block can be erased using this function. The only devices supported so far on the PICASO-GFX2 are the M25Pxx range of devices which are 512Kbit to 32Mbit (2M x 8) Serial Flash Memory.</p> <p>E.g. there are 32 x 64K blocks on a 2Mb flash device.</p>	

2.10. SPI Control Functions

The SPI functions in this section apply to any general purpose SPI device.

Summary of Functions in this section:

- spi_Init(speed, input_mode, output_mode)
- spi_Read()
- spi_Write(byte)
- spi_Disable()

2.10.1. spi_Init(speed, input_mode, output_mode)

Syntax	<code>spi_Init(speed, input_mode, output_mode);</code>	
Arguments	<code>speed, input_mode, output_mode</code>	
	speed	Sets the speed of the SPI port.
	input_mode	Sets the input mode of the SPI port. See diagram below.
	output_mode	Sets the output mode of the SPI port. See diagram below.
	The arguments can be a variable, array element, expression or constant	
Returns	nothing	
Description	Sets up the PICASO-GFX2 SPI port to communicate with SPI devices. Note: The SPI functions in this section are not necessary when using the memory card or serial flash chips interfaced to the SPI port. The SPI functions in this section are relevant to those devices other than the memory card and the serial flash chip used for media access.	

SPI MODE ARGUMENTS FOR `spi_Init(SPEED, INPUT_MODE, OUTPUT_MODE);`

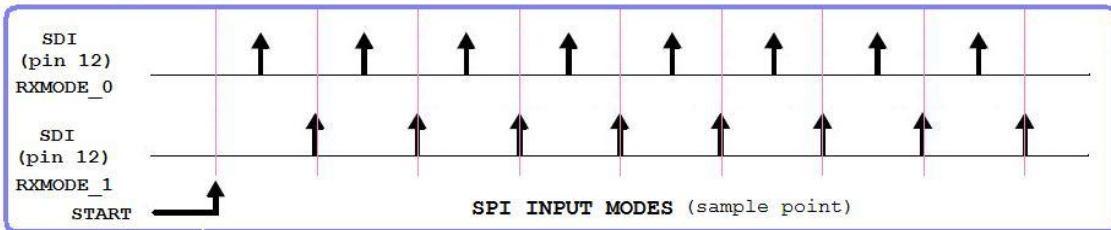
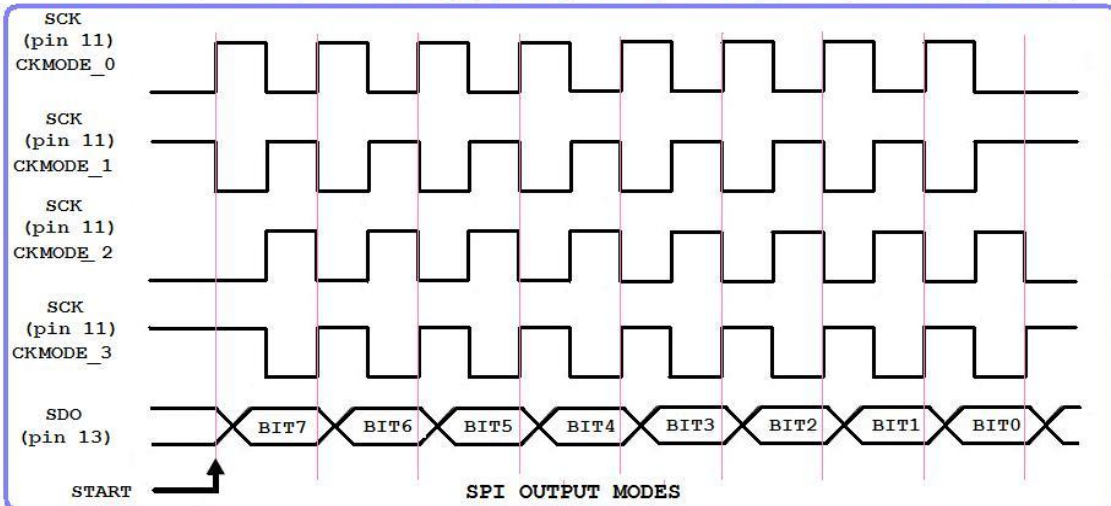

<code>spi_Init (SPI SPEED , SPI INPUT MODE , SPI OUTPUT MODE);</code>		
<code>2</code>	<code>SPI_SLOW (650 khz)</code>	<code>0</code> <code>CKMODE_0</code>
<code>1</code>	<code>SPI_MED (4mhz)</code>	<code>1</code> <code>CKMODE_1</code>
<code>0</code>	<code>SPI_FAST (16mhz)</code>	<code>2</code> <code>CKMODE_2</code>
		<code>3</code> <code>CKMODE_3</code>
	<code>0</code> <code>RXMODE_0</code>	
	<code>1</code> <code>RXMODE_1</code>	

2.10.2. spi_Read()

Syntax	<code>spi_Read();</code>	
Arguments	none	
Returns	byte	
	byte	Returns a single data byte from the SPI device.
Description	This function allows a raw unadorned byte read from the SPI device. Note: The Chip Select line (SDCS) is lowered automatically.	

2.10.3. spi_Write(byte)

Syntax	<code>spi_Write(byte);</code>	
Arguments	byte	
	byte	specifies the data byte to be sent to the SPI device.
	The arguments can be a variable, array element, expression or constant	
Returns	nothing	
Description	This function allows a raw unadorned byte write to the SPI device. Note: The Chip Select line (SDCS) is lowered automatically.	

2.10.4. spi_Disable()

Syntax	<code>spi_Disable();</code>
Arguments	none
Returns	nothing
Description	This function raises the Chip Select (SDCS) line of the SPI device, disabling it from further activity. The CS line will be automatically lowered next time the SPI functions <code>spi_Read()</code> or <code>spi_Write(...)</code> are used, and also by action of any of the <code>media_</code> functions.

2.11. Serial (UART) Communications Functions

Summary of Functions in this section:

- `setbaud(rate)`
- `com_SetBaud(comport, baudrate/10)`
- `serin()` or `serin1()`
- `serout(char)` or `serout1(char)`
- `com_Init(buffer, buffsize, qualifier)` or `com1_Init(buffer, buffsize, qualifier)`
- `com_Reset()` or `com1_Reset()`
- `com_Count()` or `com1_Count()`
- `com_Full()` or `com1_Full()`
- `com_Error()` or `com1_Error()`
- `com_Sync()` or `com1_Sync()`
- `com_TXbuffer(buf, bufsize,pin)` or `com1_TXbuffer(buf, bufsize,pin)`
- `com_TXbufferHold(state)`
- `com_TXcount()` or `com1_TXcount()`
- `com_TXemptyEvent(function)` or `com1_TXemptyEvent(function)`

2.11.1. setbaud(rate)

Syntax	setbaud(rate);																																																																			
Arguments	rate																																																																			
	rate	specifies the baud rate divisor value or pre-defined constant																																																																		
	The arguments can be a variable, array element, expression or constant																																																																			
Returns	nothing																																																																			
Description	<p>Use this function to set the required baud rate. The default Baud Rate for COM0 is 115,200 bits per second or 115,200 baud. The default Baud Rate for COM1 is 9600 bits per second or 9600 baud.</p> <p>There are pre-defined baud rate constants for most common baud rates:</p> <table border="1"> <thead> <tr> <th>Pre Defined Constant</th> <th>Error %</th> <th>Actual Baud Rate</th> </tr> </thead> <tbody> <tr><td>BAUD_110</td><td>0.00%</td><td>110</td></tr> <tr><td>BAUD_300</td><td>0.00%</td><td>300</td></tr> <tr><td>BAUD_600</td><td>0.01%</td><td>600</td></tr> <tr><td>BAUD_1200</td><td>0.03%</td><td>1200</td></tr> <tr><td>BAUD_2400</td><td>0.07%</td><td>2402</td></tr> <tr><td>BAUD_4800</td><td>0.16%</td><td>4808</td></tr> <tr><td>BAUD_9600</td><td>0.33%</td><td>9632</td></tr> <tr><td>BAUD_14400</td><td>0.16%</td><td>14423</td></tr> <tr><td>BAUD_19200</td><td>0.33%</td><td>19264</td></tr> <tr><td>BAUD_31250</td><td>0.00%</td><td>31250</td></tr> <tr><td>MIDI</td><td>0.00%</td><td>31250</td></tr> <tr><td>BAUD_38400</td><td>0.33%</td><td>38527</td></tr> <tr><td>BAUD_56000</td><td>0.45%</td><td>56250</td></tr> <tr><td>BAUD_57600</td><td>1.73%</td><td>58594</td></tr> <tr><td>BAUD_115200</td><td>1.73%</td><td>117188</td></tr> <tr><td>BAUD_128000</td><td>4.63%</td><td>133929</td></tr> <tr><td>BAUD_256000</td><td>9.86%</td><td>281250</td></tr> <tr><td>BAUD_300000</td><td>4.17%</td><td>312500</td></tr> <tr><td>BAUD_375000</td><td>7.14%</td><td>401786</td></tr> <tr><td>BAUD_500000</td><td>12.50%</td><td>562500</td></tr> <tr><td>BAUD_600000</td><td>17.19%</td><td>703125</td></tr> </tbody> </table> <p>The baud rate is calculated with the following formula: rate-divisor = (3000000 / baud) - 1</p>		Pre Defined Constant	Error %	Actual Baud Rate	BAUD_110	0.00%	110	BAUD_300	0.00%	300	BAUD_600	0.01%	600	BAUD_1200	0.03%	1200	BAUD_2400	0.07%	2402	BAUD_4800	0.16%	4808	BAUD_9600	0.33%	9632	BAUD_14400	0.16%	14423	BAUD_19200	0.33%	19264	BAUD_31250	0.00%	31250	MIDI	0.00%	31250	BAUD_38400	0.33%	38527	BAUD_56000	0.45%	56250	BAUD_57600	1.73%	58594	BAUD_115200	1.73%	117188	BAUD_128000	4.63%	133929	BAUD_256000	9.86%	281250	BAUD_300000	4.17%	312500	BAUD_375000	7.14%	401786	BAUD_500000	12.50%	562500	BAUD_600000	17.19%	703125
Pre Defined Constant	Error %	Actual Baud Rate																																																																		
BAUD_110	0.00%	110																																																																		
BAUD_300	0.00%	300																																																																		
BAUD_600	0.01%	600																																																																		
BAUD_1200	0.03%	1200																																																																		
BAUD_2400	0.07%	2402																																																																		
BAUD_4800	0.16%	4808																																																																		
BAUD_9600	0.33%	9632																																																																		
BAUD_14400	0.16%	14423																																																																		
BAUD_19200	0.33%	19264																																																																		
BAUD_31250	0.00%	31250																																																																		
MIDI	0.00%	31250																																																																		
BAUD_38400	0.33%	38527																																																																		
BAUD_56000	0.45%	56250																																																																		
BAUD_57600	1.73%	58594																																																																		
BAUD_115200	1.73%	117188																																																																		
BAUD_128000	4.63%	133929																																																																		
BAUD_256000	9.86%	281250																																																																		
BAUD_300000	4.17%	312500																																																																		
BAUD_375000	7.14%	401786																																																																		
BAUD_500000	12.50%	562500																																																																		
BAUD_600000	17.19%	703125																																																																		

2.11.2. com_SetBaud(comport, baudrate/10)

Syntax	<code>com_SetBaud("comport", "baudrate/10");</code>	
Arguments	comport, baudrate/10	
	comport	Com port, COM0 or COM1.
	baudrate/10	Specifies the baud rate .
	The arguments can be a variable, array element, expression or constant	
Returns	Status	
	Status	Returns True if BAUD rate was acceptable.
Description	Use this function to set the required baud rate for the required Com port.	
Example	<pre> stat := com_SetBaud(COM1, 960) // To set Com1 to 9600 BAUD rate. if (stat) Print("Com1 set to 9600 BAUD"); endif </pre>	

2.11.3. serin()

Syntax	<code>serin();</code> or <code>serin1();</code>	
Arguments	none	
Returns	char	
	char	Returns: -1 if no character is available Returns: -2 if a framing error or over-run has occurred (auto cleared) Returns: positive value 0 to 255 for a valid character received
Description	<p>serin(): Receives a character from the Serial Port COM0. serin1(): Receives a character from the Serial Port COM1.</p> <p>The transmission format is: No Parity, 1 Stop Bit, 8 Data Bits (N,8,1).</p> <p>The default Baud Rate for COM0 is 115,200 bits per second or 115,200 baud. The default Baud Rate for COM1 is 9600 bits per second or 9600 baud.</p> <p>The baud rate can be changed under program control by using the setbaud(...) function.</p>	
Example	<pre>var char; char := serin(); // test the com port if (char >= 0) // if a valid character is received process(char); // process the character endif</pre>	

2.11.4. serout(char)

Syntax	<code>serout(char);</code> or <code>serout(1char);</code>	
Arguments	char	
	char	specifies the data byte to be sent to the serial port.
	The arguments can be a variable, array element, expression or constant	
Returns	nothing	
Description	<p>serout(): Transmits a single byte from the Serial Port COM1. serout1(): Transmits a single byte from the Serial Port COM1.</p> <p>The transmission format is: No Parity, 1 Stop Bit, 8 Data Bits (N,8,1). The default Baud Rate for COM0 is 115,200 bits per second or 115,200 baud. The default Baud Rate for COM1 is 9600 bits per second or 9600 baud.</p> <p>The baud rate can be changed under program control by using the setbaud(...) function.</p>	
Example	<code>serout('\n');</code> <code>\\Send a linefeed to COM0.</code>	

2.11.5. com_Init(buffer, bufsize, qualifier)

Syntax	com_Init(buffer, bufsize, qualifier); or com1_Init(buffer, bufsize, qualifier);	
Arguments	buffer, bufsize, qualifier	
	buffer	specifies the address of a buffer used for the background buffering service.
	bufsize	specifies the byte size of the user array provided for the buffer (each array element holds 2 bytes). If the buffer size is zero, a buffer of 128 words (256 bytes) should be provided for automatic packet length mode (see below).
	qualifier	specifies the qualifying character that must be received to initiate serial data reception and buffer write. A zero (0x00) indicates no qualifier to be used.
	The arguments can be a variable, array element, expression or constant	
Returns	nothing	
Description	<p>This is the initialisation function for the serial communications buffered service. Once initialised, the service runs in the background capturing and buffering serial data without the user application having to constantly poll the serial port. This frees up the application to service other tasks.</p> <p><u>MODES OF OPERATION</u></p> <ul style="list-style-type: none"> • <u>No qualifier – simple ring buffer (aka circular queue)</u> <p>If the qualifier is set to zero, the buffer is continually active as a simple circular queue. Characters when received from the host are placed in the circular queue (at the 'head' of the queue) Bytes may be removed from the circular queue (from the 'tail' of the queue) using the serin() function. If the tail is the same position as the head, there are no bytes in the queue, therefore serin() will return -1, meaning no character is available, also, the com_Count() function can be read at any time to determine the number of characters that are waiting between the tail and head of the queue. If the queue is not read frequently by the application, and characters are still being sent by the host, the head will eventually catch up with the tail setting the internal COM_FULL flag (which can be read with the com_Full() function) . Any further characters from the host are now discarded, however, all the characters that were buffered up to this point are readable. This is a good way of reading a fixed size packet and not necessarily considered to be an error condition. If no characters are removed from the buffer until the COM_FULL flag (which can be read with the com_Full() function) becomes set, it is guaranteed that the bytes will be ordered in the buffer from the start position, therefore, the buffer can be treated as an array and can be read directly without using serin() at all. In the latter case, the correct action is to process the data from the buffer, re-initialise the buffer with the com_Init(..) function, or reset the buffered serial service by issuing the com_Reset() function (which will return serial reception to polled mode) , and send an acknowledgement to the host (traditionally a ACK or 6) to indicate that the application is ready to receive more data and the previous 'packet' has been dealt with, or conversely, the application may send a negative acknowledgement to indicate that some sort of error occurred, or the action could not be completed (traditionally a NAK or 16) .</p> <p>If any low level errors occur during the buffering service (such as framing or over-run) the internal COM_ERROR flag will be set (which can be read with the com_Error() function). Note that the COM_FULL flag will remain latched to indicate that the buffer did become full, and is not reset (even if all the characters are read) until the</p>	

	<p>com_Init(..) or com_Reset() function is issued.</p> <ul style="list-style-type: none">• Using a qualifier <p>If a qualifier character is specified, after the buffer is initialised with com_Init(..), the service will ignore all characters until the qualifier is received and only then initiate the buffer write sequence with incoming data. After that point, the behaviour is the same as above for the 'non qualified' mode.</p>
Example	<pre>com_Init(combuf, 20, 0); // set up a comms ring buffer, maximum 12 characters before overflow</pre>

2.11.6. com_Reset()

Syntax	<code>com_Reset();</code> or <code>com1_Reset();</code>
Arguments	none
Returns	nothing
Description	Resets the serial communications buffered service and returns it to the default polled mode.
Example	<pre>com_Reset(); // reset to polled mode</pre>

2.11.7. com_Count()

Syntax	<code>com_Count();</code> or <code>com1_Count();</code>	
Arguments	none	
Returns	count	
	count	current count of characters in the communications buffer.
Description	Can be read at any time (when in buffered communications is active) to determine the number of characters that are waiting in the buffer.	
Example	<pre>n := com_Count(); // get the number of chars available in the buffer</pre>	

2.11.8. com_Full()

Syntax	<code>com_Full();</code> or <code>com1_Full();</code>	
Arguments	none	
Returns	status	
	status	Returns 1 if buffer or queue has become full, or is overflowed, else returns 0 .
Description	If the queue is not read frequently by the application, and characters are still being sent by the host, the head will eventually catch up with the tail setting the COM_FULL flag which is read with this function. If this flag is set, any further characters from the host are discarded, however, all the characters that were buffered up to this point are readable.	
Example	<pre>if(com_Full() & (com_Count() == 0)) com_Init(mybuf, 30, 0); // buffer full, recovery endif</pre>	

2.11.9. com_Error()

Syntax	<code>com_Error();</code> or <code>com1_Error();</code>	
Arguments	none	
Returns	status	
	status	Returns 1 if any low level communications error occurred, else returns 0 .
Description	If any low level errors occur during the buffering service (such as framing or over-run) the internal COM_ERROR flag will be set which can be read with this function.	
Example	<pre> if(com_Error()) // if there were low level comms errors, resetMySystem(); // take corrective action endif </pre>	

2.11.10. com_Sync()

Syntax	<code>com_Sync();</code> or <code>com1_Sync();</code>	
Arguments	none	
Returns	status	
	status	Returns 1 if the qualifier character has been received, else returns 0 .
Description	If a <i>qualifier</i> character is specified when using buffered communications, after the buffer is initialized with <code>com_Init(..)</code> , the service will ignore all characters until the <i>qualifier</i> is received and only then initiate the buffer write sequence with incoming data. <code>com_Sync()</code> is called to determine if the qualifier character has been received yet.	
Example	<code>com_Sync(); // reset to polled mode</code>	

2.11.11. com_TXbuffer(buf, bufsize, pin)

Syntax	<code>com_TXbuffer(buf, bufsize, pin);</code> or <code>com1_TXbuffer(buf, bufsize, pin);</code>	
Arguments	buf, bufsize, pin	
	buf	Specifies the address of a buffer used for the buffering service.
	bufsize	Specifies the byte size of the user array provided for the buffer (each array element holds 2 bytes).
	pin	Specifies the turnaround pin. If not required, just set "pin" to zero.
	The arguments can be a variable, array element, expression or constant	
Returns	None	
Description	<p>Initialise a serial buffer for the COM0 or COM1 output. The program must declare a var array as a circular buffer. When a TX buffer is declared for comms, the transmission of characters becomes non blocking. The only time blocking will occur is if the buffer has insufficient space to accept the next character, in which case the function will wait for buffer space to become available. If the TX buffer is no longer required, just set the buffer pointer to zero, the size in this case doesn't matter and is ignored. The function can resize or reallocated to another buffer at any time. The buffer is flushed before any changes are made.</p> <p>"pin" designates an IO pin to control a bi-directional control device for half duplex mode. "pin" will go HI at the start of a transmission, and will return low after the final byte is transmitted.</p>	
Example	<pre>com_TXbuffer(mybuf, 1024, IO1_PIN); // set the TX buffer com_TXbuffer(0, 0, 0); // revert to non buffered service</pre>	

2.11.12. com_TXbufferHold(state)

Syntax	<code>com_TXbufferHold(state);</code> or <code>com1_TXbufferHold(state);</code>	
Arguments	state	
	state	Specifies the state of the buffer used for the buffering service.
	The arguments can be a variable, array element, expression or constant	
Returns	count	
	count	Returns buffer count when called with argument of 1, for example com_TXbufferHold(ON) Returns 0 when argument is zero, eg com_TXbufferHold(OFF)
Description	<p>This function is used in conjunction with com_TXbuffer(...) ;</p> <p>It is often necessary to hold off sending serial characters until a complete frame or packet has been built in the output buffer. com_TXbufferHold(ON) is used for this, to stop the buffer being sent while it is being loaded. Normally, when using buffered comms, the transmit process will begin immediately. This is fine unless you are trying to assemble a packet.</p> <p>To build a packet and send it later, issue a com_TXbufferHold(ON);; build the packet, when packet is ready, issuing com_TXbufferHold(OFF); will release the buffer to the com port.</p> <p>Also, if using com_TXemptyEvent, erroneous empty events will occur as the transmit buffer is constantly trying to empty while you are busy trying to fill it.</p> <p>Also refer to the pin control for com_TXbuffer(...) function.</p>	
Example	Refer to the com_TXemptyEvent(functionAddress) example.	

2.11.13. com_TXcount()

Syntax	<code>com_TXcount();</code> or <code>com1_TXcount();</code>	
Arguments	None	
Returns	count	
	count	Returns count of characters
Description	Return count of characters remaining in COM0 or COM1 transmit buffer that was previously allocated with <code>com_TXbuffer(...);</code> or <code>com1_TXbuffer(...);</code>	
Example	<code>arg := com1_TXCount(); //return count of characters in COM1 TX buffer</code>	

2.11.14. com_TXemptyEvent(function)

Syntax	com_TXemptyEvent(functionAddress); or com1_TXemptyEvent(functionAddress);	
Arguments	functionAddress	
	functionAddress	Address of the Function to be called when COM0 TX buffer empty
Returns	Address	
	Address	Returns any previous event function address, or zero if there was no previous function.
Description	<p>If a comms TX buffer that was previously allocated with com_TXbuffer(...); or com1_TXbuffer(...); this function can be used to set up a function to be called when the COM0 or COM1 TX buffer is empty.</p> <p>This is useful for either reloading the TX buffer, setting or clearing a pin to change the direction of eg a RS485 line driver, or any other form of traffic control. The event function must not have any parameters. To disable the event, simply call com_TXemptyEvent(0) or com1_TXemptyEvent(0).</p> <p>com_TXbuffer(...); or com1_TXbuffer(...); also resets any active event.</p>	
Example	<pre>#platform "uLCD-32PT_GFX2" /***** * Description: buffered TX service * Use Workshop terminal at 9600 baud to see result * Example of Buffered TX service vs Non buffered * Also explains the use of COMMS events * * NB Program must be written to flash so * the Workshop Terminal can be used. * *****/ var combuf[220]; // buffer for up to 440 bytes // run a timer event while we are doing comms func T7Service() var private colour := 0xF800; colour ^= 0xF800; gfx_RectangleFilled(50,200,80,220,colour); sys_SetTimer(TIMER7, 200); endfunc // event to capture the buffer empty event func bufEmpty() com_TXbuffer(0, 0, IO1_PIN); // done with the buffer, release it print("\n\nHELLO WORLD, I'M EMPTY ",com_TXcount(),"\n"); endfunc func main() var n, r, D, fh; sys_SetTimerEvent(TIMER7,T7Service); // run a timer event sys_SetTimer(TIMER7, 150); com_TXemptyEvent(bufEmpty); // set to capture buffer empty event setbaud(BAUD_9600);</pre>	

```

txt_Set(TEXT_OPACITY, OPAQUE);
repeat
  gfx_Cls();

  txt_MoveCursor(3,1);          // reset cursor to line 3, column 2
  print("Send 440 chars non-buffered\n");
  pokeW(SYSTEM_TIMER_LO, 0); // reset timer

  // note that 440 chars at 9600 baud takes approx 453msec
  for(n:=0; n<10; n++)
    to(COM0); putstr("The quick brown fox jumps over the lazy
dog\n"); // 44 chars
  next

  print("took ",peekW(SYSTEM_TIMER_LO),"Msec\n\n");
  // time spent blocking is only approx 1msec

  com_TXbuffer(combuf, 440,IO1_PIN);// set up the TX buffer
  com_TXbufferHold(ON);           // hold the TX buffer til ready

  // note that here the time is only approx 1msec overhead due to
  buffering.
  print("Send 440 chars buffered\n");
  pokeW(SYSTEM_TIMER_LO, 0);      // reset timer

  for(n:=0; n<10; n++)
    to(COM0); putstr("THE QUICK BROWN FOX JUMPS OVER THE LAZY
DOG\n"); // 44 chars
  next

  print("took ",peekW(SYSTEM_TIMER_LO),"Msec\n\n");
  // time spent blocking is only approx 1msec

  // demonstrate how to modify a prepared comms buffer that is
  still being held
  to(combuf); print("MY CONTENTS HAVE BEEN CHANGED");
  to(combuf+50); print("*** AND CHANGED HERE TOO ***");
  combuf[218] := 'CA'; // the last 'DOG' changed here
  combuf[219] := 'T\n'; // the last 'DOG' changed here

  // now we are ready to send to buffer
  n := com_TXbufferHold(OFF); // release TX buffer
  print("TXBuffer is holding ", n, " chars\n");
  // show how many characters were in the buffer

  // watch the buffer empty
  repeat
    print("TX count = ", [DEC5ZB] n := com_TXcount(),"\r"); //
watch the count as the buffer empties
  until(!n);

  print("\n\nTX Empty");

  com_TXbuffer(0, 0, IO1_PIN); // done with the buffer, release it

  sys_SetTimer(TIMER0, 3000); // pause for 3 seconds, non blocking
  while(peekW(TMR0));

forever // do it forever
//com_TXbuffer(0, 0, 0); // if done with the pin, must release it

endfunc

```

2.12. I2C BUS Master Functions

Summary of Functions in this section:

- func I2C_Open(Speed)
- func I2C_Close()
- func I2C_Start()
- func I2C_Stop()
- func I2C_Restart()
- func I2C_Read()
- func I2C_Write(byte)
- func I2C_Ack()
- func I2C_Nack()
- func I2C_AckStatus()
- func I2C_AckPoll(control)
- func I2C_Idle()
- func I2C_Gets(buffer, size)
- func I2C_Getn(buffer, size)
- func I2C_Puts(buffer)
- func I2C_Putn(buffer,count)

2.12.1. I2C_Open(Speed)

Syntax	I2C_Open(Speed);									
Arguments	Speed									
	Speed	Specifies the I2C bus speed Speed can be I2C_SLOW, I2C_MED, I2C_FAST (100khz, 400khz, 1mhz)								
	The arguments can be a variable, array element, expression or constant									
Returns	None									
Description	<p>Calling this function configures the I2C module and initialises it to be ready for service. The I2C clock speed is specified by the speed parameter. Three I2C Speed settings are available to suit various requirements.</p> <table border="1"> <thead> <tr> <th>Constant</th> <th>Speed</th> </tr> </thead> <tbody> <tr> <td>I2C_SLOW</td> <td>100khz</td> </tr> <tr> <td>I2C_MED</td> <td>400khz</td> </tr> <tr> <td>I2C_FAST</td> <td>1mhz</td> </tr> </tbody> </table>		Constant	Speed	I2C_SLOW	100khz	I2C_MED	400khz	I2C_FAST	1mhz
Constant	Speed									
I2C_SLOW	100khz									
I2C_MED	400khz									
I2C_FAST	1mhz									
Example	<code>I2C_Open(I2C_MED); // Open the I2C port in 400KHz mode.</code>									

2.12.2. I2C_Close()

Syntax	<code>I2C_Close();</code>
Arguments	None
Returns	None
Description	Calling this function closes the I2C port and disables the I2C hardware
Example	<code>I2C_Close(); // Close I2C port and Disable the hardware</code>

2.12.3. I2C_Start

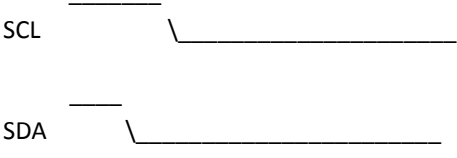
Syntax	<code>I2C_Start();</code>
Arguments	None
Returns	None
Description	<p>Calling this function sends an I2C start condition. The hardware first pulls the SDA (data) line low, and next pulls the SCL (clock) line low.</p>  <p>The diagram shows two signals: SCL and SDA. SDA starts high, then drops to low. After a short delay, SCL also drops to low. Both lines remain low for a period before returning to high.</p>
Example	<pre>I2C_Start(); //Send an I2C start condition.</pre>

2.12.4. I2C_Stop

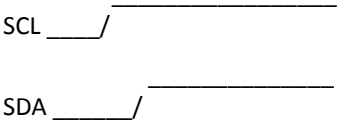
Syntax	<code>I2C_Stop();</code>
Arguments	None
Returns	None
Description	<p>Calling this function sends an I2C stop condition. The hardware first releases the SCL to high state, and then releases the SDA line high.</p>  <p>The diagram shows two signals: SCL and SDA. SCL starts at a low level, then transitions to a high level. SDA starts at a low level, then transitions to a high level after SCL has reached its high state.</p>
Example	<code>I2C_stop(); //</code>

2.12.5. I2C_Restart()

Syntax	I2C_Restart();
Arguments	None
Returns	None
Description	Calling this function generates a restart condition.
Example	<pre>I2C_Restart() ; //Generates an I2C restart condition</pre>

2.12.6. I2C_Read

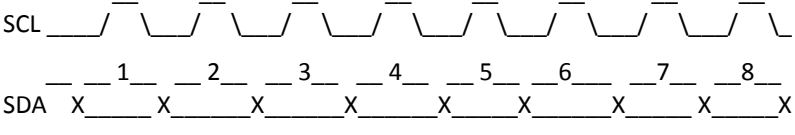
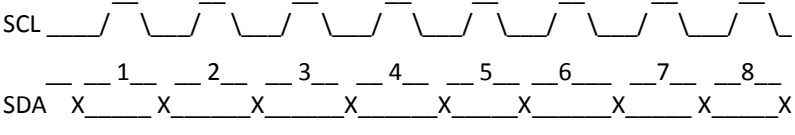
Syntax	I2C_Read();	
Arguments	None	
Returns	Byte	
	Byte	Byte from the I2C Bus in the lower 8 bits.
Description	<p>Calling this function reads a single byte from the I2C bus. Note: Data can only change when the clock is low.</p>  <p>SCL </p> <p>SDA X X X X X X X X</p>	
Example	<pre>c := I2C_Read() ; //Read a single byte from the I2C Bus.</pre>	

2.12.7. I2C_Write(byte)

Syntax	I2C_Write(byte);	
Arguments	byte	
	byte	The byte to be written to the I2C Bus.
	The arguments can be a variable, array element, expression or constant	
Returns	Status	
	Status	Returns True if OK.
Description	<p>Calling this function sends a single byte to the I2C bus</p> <p>SCL </p> <p>SDA X <u>1</u> X <u>2</u> X <u>3</u> X <u>4</u> X <u>5</u> X <u>6</u> X <u>7</u> X <u>8</u> X</p>	
Example	<code>Status := I2C_Write(bytevalue); // Send a single byte to the I2C</code>	

2.12.8. I2C_Ack

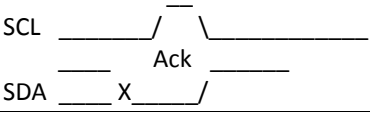
Syntax	I2C_Ack();
Arguments	None
Returns	None
Description	<p>Calling this function sends an I2C acknowledge condition. The hardware first pulls the SDA line low, and next releases SCL high followed by pulling SCL low again thus generating a clock pulse, SDA is then released high.</p> <p>NB:- Data can only change when the clock is low.</p>  <p>The diagram shows two signals: SCL and SDA. SCL starts at a high level, then transitions to low, then back to high, and finally to low again. SDA starts at a high level, then transitions to low (indicated by an 'X' below the line), and then back to high. The SCL pulse (low-to-high-to-low) occurs while SDA is low.</p>
Example	<pre>I2C_Ack(); // Send I2C Acknowledge condition</pre>

2.12.9. I2C_Nack()

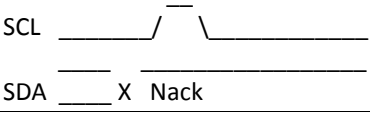
Syntax	<code>I2C_Nack();</code>
Arguments	None
Returns	None
Description	<p>Calling this function sends an I2C negative acknowledge condition. The hardware first release the SDA line high, and next releases SCL HI followed by pulling SCL low thus generating a clock pulse.</p> <p>NB:- Data can only change when the clock is low.</p>  <p>SCL _____ / \ _____</p> <p>SDA _____ X Nack</p>
Example	<code>I2C_Nack(); //Send an I2C Negative acknowledge condition</code>

2.12.10. I2C_AckStatus

Syntax	I2C_AckStatus();	
Arguments	None	
Returns	Status	
	Status	Device Ack status
Description	<p>Call this function to get the ACK status from the slave device The state of SDA is returned.</p> <p>NB:- returns the state of SDA after the last clock pulse</p> <p>_____ Previous Clock Pulse</p> <p>SCL X _____</p> <p>SDA _____ X _____ Ack Status</p>	
Example	<pre>r := I2C_AckStatus();// returns the Ack Status.</pre>	

2.12.11. I2C_AckPoll(control)

Syntax	I2C_AckPoll(control);	
Arguments	control	
	control	The control word to be written to the device.
	The arguments can be a variable, array element, expression or constant	
Returns	Status	
	Status	Device Ack Status
Description	<p>Call this function to wait for a device to return an ACK during ACK polling The SDA is monitored for an Ack.</p> <p>NB:- returns the state of SDA after the last clock pulse</p> <p>_____ Previous Clock Pulse SCL X _____</p> <p>SDA _____ X _____ Ack Status</p>	
Example	<pre>r := I2C_AckPoll(0xA0); //send the control byte the wait for a device //to return poll the device until an ACK //is received.</pre>	

2.12.12. I2C_Idle()

Syntax	I2C_Idle();	
Arguments	None	
Returns	Status	
	Status	Device Ack Status
Description	<p>Call this function to wait until the I2C bus is inactive. NB:- wait for the bus to become idle.</p> <p>SCL X ___X / _____</p> <p>SDA X ___X / _____</p>	
Example	<pre>r := I2C_Idle(); //Wait until the I2C Bus is inactive.</pre>	

2.12.13. I2C_Gets(buffer, size)

Syntax	I2C_Gets(buffer, size);	
Arguments	buffer, size	
	buffer	Storage for the string being read from the device.
	Size	Maximum size of the string to be read
Returns	Count	
	Count	Returns the count of bytes actually read.
Description	Reads up to size characters into buffer from an ascii string stored in a device. Reads up to the ASCII NULL terminator and includes the terminator.	
Example	<pre>c := I2C_Gets(buf, size); //read a string from the I2C Bus to buffer //up to size characters.</pre>	

2.12.14. I2C_Getn

Syntax	<code>I2C_Getn(buffer, count);</code>	
Arguments	buffer, count	
	buffer	Storage for the bytes being read from the device.
	count	Number of bytes to be read
	The arguments can be a variable, array element, expression or constant	
Returns	Status	
	Status	Returns True if block read ok else returns False.
Description	Reads count bytes in to buffer and returns True if function succeeds	
Example	<pre>I2C_Getn(buffer, count); //read I2C count bytes from the I2C Bus to //the buffer</pre>	

2.12.15. I2C_Puts(buffer)

Syntax	I2C_Puts(buffer);	
Arguments	buffer	
	buffer	Storage for the string being written to the device.
	The arguments can be a variable, array element, expression or constant	
Returns	Count	
	Count	Returns the count of bytes actually written.
Description	Writes an ASCII string from buffer to a device. The ASCII NULL terminator is also written.	
Example	<pre>c := I2C_Puts(mybuf); //write an ASCII string from buffer to the I2C //bus</pre>	

2.12.16. I2C_Putn

Syntax	I2C_Putn(buffer, count);	
Arguments	buffer, count	
	buffer	Storage for the bytes being written to the device.
	count	Number of bytes to be written
Returns	Count	
	Count	Returns number of bytes written.
Description	Writes count bytes from the buffer to the device, and returns count if function succeeds.	
Example	<pre>b := I2C_Putn(mybuf, count); // write count bytes from the buffer to // the I2C bus.</pre>	

2.13. Timer Functions

Summary of Functions in this section:

- `sys_T()`
- `sys_T_HI()`
- `sys_SetTimer(timernum, value)`
- `sys_GetTimer(timernum)`
- `sys_SetTimerEvent("timernum","function")`
- `sys_EventQueue()`
- `sys_EventsPostpone()`
- `sys_EventsResume()`
- `sys_Sleep(units)`
- `iterator(offset)`

2.13.1. sys_T()

Syntax	<code>sys_T();</code>	
Arguments	None	
Returns	value	
	value	Returns the value of system timer. (LO Word)
Description	Returns the current value of the rolling 32bit system timer (1mse) LO word.	
Example	<code>t := sys_T(); // .</code>	

2.13.2. sys_T_HI()

Syntax	<code>sys_T_HI();</code>	
Arguments	None	
Returns	value	
	value	Returns the value of system timer. (HI Word)
Description	Returns the current value of the rolling 32bit system timer (1mse) HI word.	
Example	<pre>t := sys_T_HI(); //</pre>	

2.13.3. sys_SetTimer(timernum, value)

Syntax	<code>sys_SetTimer(timernum, value);</code>	
Arguments	timernum, value	
	timernum	One of eight timers TIMER0 to TIMER7.
	value	Countdown period in milliseconds.
	The "value" can be a variable, array element, expression or constant	
Returns	None	
Description	Set a countdown on the selected timer or 'top-up' if required. There are 8 timers TIMER0 to TIMER7 which stop at the count of 0. Maximum timeout period is 65, 535 milliseconds or 65.535 seconds. A timer can be read with the <code>sys_GetTimer("timernum")</code> function.	
Example	<code>sys_SetTimer(TIMER5, 3600); //Set Timer5 for 1 hour.</code>	

2.13.4. sys_GetTimer(timernum)

Syntax	<code>sys_GetTimer(timernum);</code>	
Arguments	timernum	
	timernum	One of eight timers TIMER0 to TIMER7.
Returns	Value	
	Value	Returns 0 if timer has expired, or the current countdown value.
Description	Returns 0 if timer has expired, or the current countdown value. There are 8 timers TIMER0 to TIMER7 which stop at the count of 0. Maximum timeout period is 65, 535 milliseconds or 65.535 seconds. A timer can be set with the <code>sys_SetTimer("timernum", "value")</code> function.	
Example	<code>t := sys_GetTimer(TIMER2); //</code>	

2.13.5. sys_SetTimerEvent(timernum, function)

Syntax	<code>sys_SetTimerEvent(timernum, function);</code>	
Arguments	timernum, function	
	timernum	One of eight timers TIMER0 to TIMER7.
	function	Function to be called
Returns	Address	
	Address	Returns any previous event function address, or zero if there was no previous function.
Description	<p>Set a function to be called for selected timer. When the timer reaches zero, the function is called. The called function must not have any parameters, and should not have a return value. This is necessary because the timer event is invoked asynchronously to the mainline program (i.e, it is not called in the normal way, so parameters and return values don't apply).</p> <p>Note: When a child process is run using the file_run or file_exec function, or if a file was loaded with file_Loadfunction and is executed, the loaded process gets its own code and memory space, therefore, any timer that reaches zero that has a timer event attached in the parent code space, will fail and cause a crash as an attempt is made to force the program counter to some wild place in the child process - There are 2 ways to overcome this problem.</p> <p>1] If a child process will not be requiring the use of any timers or timer events, the parent program can simply use the eventsPostpone() function before calling or entering the child process. Once the parent program regains control, the eventsResume() function will allow any events in the queue to then be processed. The side effect of this method is that several events may bank up, and will execute immediately once the eventsResume() takes place. This however disallows a child process to use any timer events in the sub program so method 2 is preferable in this case.</p> <p>2] The parent program can 'disconnect' the event(s) by setting it/them to zero prior to child process execution, or setting the associated timer to zero so the event wont fire. In either case, it is necessary to do the following:- <pre>while(sys_EventQueue());</pre> to ensure the event queue is empty prior to calling the child process. Note also that if just the timer is set to zero, the child process cannot use this timer. If the timer was now set to a value and the old event still existed, when the timer reaches zero the 'bad' parent address event will fire causing a crash.</p> <p>The reverse situation also applies of course, the same level of respect is required if a child program needs to use any timer events. Method [1] (above) will not work as the events have been postponed, stopping the child process from using any timer events. If the child process did an eventsResume() in this case, everything would crash miserably. So the same applies, a child that uses any timer events must respect any timers that may be used by the parent, and a child must zero the sys_SetTimerEvent before returning to the parent.</p>	
Example	<code>sys_SetTimerEvent(TIMER5, myfunc);</code>	

2.13.6. sys_EventQueue()

Syntax	<code>sys_EventQueue();</code>	
Arguments	None	
Returns	Count	
	Count	Returns number of events .
Description	returns the max number of events that were pending in the timer queue since the last call to this function. This can be used to assess timer event overhead burden, especially after or during a sys_EventsPostpone action..	
Example	<code>tasks := sys_EventQueue(); //</code>	

2.13.7. sys_EventsPostpone()

Syntax	<code>sys_EventsPostpone();</code>
Arguments	None
Returns	None
Description	<p>Postpone any events until the <code>sys_EventResume</code> function is executed. The timer event queue will continue to queue events, but no action will take place until a <code>sys_EventResume</code> function is encountered.</p> <p>The queue will continue to receive up to 32 events before discarding any further events. This function is required to allow a sequence of instructions or functions to occur that would otherwise be corrupted by an event occurring during the sequence of instructions or functions. A good example of this is when you set a position to print, if there was no way of locking the current sequence, an event may occur which does a similar thing, and a contention would occur - printing to the wrong position. This function should be used wisely, if any action that is required would take considerable time, it is better to disable any conflicting event functions with a bypass flag, then restart the conflicting event by re-issuing a timer value.</p>
Example	<code>sys_EventsPostpone(); // postpone the event queue</code>

2.13.8. sys_EventsResume()

Syntax	<code>sys_EventsResume();</code>
Arguments	None
Returns	None
Description	Resume any postponed events. The queue will try to execute any timer events that were incurred during the postponed period.
Example	<code>sys_EventsResume(); // resume the event queue</code>

2.13.9. sys_Sleep(units)

Syntax	<code>sys_Sleep(units);</code>	
Arguments	units	
	units	Sleep timer units are approx 1 second. When in sleep mode, timing is controlled by an RC oscillator, therefore, timing is not totally accurate and should not be relied on for timing purposes
	The arguments can be a variable, array element, expression or constant	
Returns	Status	
	Status	Remaining time units when touch screen is touched, else returns zero.
Description	Put the display and processor into low power mode for a period of time. If "units" is zero, the display goes into sleep mode forever and needs power cycling to re-initialize. If "units" is 1 to 65535, the display will sleep for that period of time, or will be woken when touch screen is touched. The function returns the count of "units" that are remaining when the screen was touched. When returning from sleep mode, the display and processor are restored from low power mode. Note: Sys_Sleep() was found to have an issue in PmmC's prior to R33, the units value was not always near 1 second. This has been corrected in PmmC R33.	
Example	<code>sys_Sleep(60); // Sleep for 1 minute.</code>	

2.13.10. iterator(offset)

Syntax	<code>iterator_(offset);</code>	
Arguments	offset	
	offset	Offset size for the next ++ or -- command
	The arguments can be a variable, array element, expression or constant	
Returns	None	
Description	Sets the iterator size for the next postinc, postdec, preinc or predec by a specified value. The offset will return to 1 after the next operation.	
Example	<code>t := iterator(10); //</code>	

2.14. FAT16 File Functions

Summary of Functions in this section:

- file_Error()
- file_Count(filename)
- file_Dir(filename)
- file_FindFirst(fname)
- file_FindNext()
- file_Exists(fname)
- file_Open(fname, mode)
- file_Close(handle)
- file_Read(destination, size, handle)
- file_Seek(handle, HiWord, LoWord)
- file_Index(handle, Hisize, Losize, recordnum)
- file_Tell(handle, &HiWord, &LoWord)
- file_Write(Source, size, handle)
- file_Size(handle, &HiWord, &LoWord)
- file_Image(x, y, handle)
- file_ScreenCapture(x, y, width, height, handle)
- file_PutC(char, handle)
- file_GetC(handle)
- file_PutW(word, handle)
- file_GetW(handle)
- file_PutS(source, handle)
- file_GetS(*String, size, handle)
- file_Erase(fname)
- file_Rewind(handle)
- file_LoadFunction(fname.4XE)
- file_Run(fname.4XE, arglistptr)
- file_Exec(fname.4XE, arglistptr)
- file_LoadImageControl(fname1, fname2, mode)
- file_Mount()
- file_Unmount()
- file_PlayWAV

2.14.1. file_Error()

Syntax	file_Error();			
Arguments	None.			
Returns	Error Code			
	Error Code	ERROR CODE	ERROR NUMBER	ERROR DESCRIPTION
		FE_IDE_ERROR	1	IDE command execution error
		FE_NOT_PRESENT	2	CARD not present
		FE_PARTITION_TYPE	3	WRONG partition type, not FAT16
		FE_INVALID_MBR	4	MBR sector invalid signature
		FE_INVALID_BR	5	Boot Record invalid signature
		FE_MEDIA_NOT_MNTD	6	Media not mounted
		FE_FILE_NOT_FOUND	7	File not found in open for read
		FE_INVALID_FILE	8	File not open
		FE_FAT_EO	9	Fat attempt to read beyond EOF
		FE_EOF	10	Reached the end of file
		FE_INVALID_CLUSTER	11	Invalid cluster value > maxcls
		FE_DIR_FULL	12	All root dir entry are taken
		FE_MEDIA_FULL	13	All clusters in partition are taken
		FE_FILE_OVERWRITE	14	A file with same name exist already
		FE_CANNOT_INIT	15	Cannot init the CARD
		FE_CANNOT_READ_MBRFE	16	Cannot read the MBR
		_MALLOC_FAILED	17	Malloc could not allocate the FILE struct
		FE_INVALID_MODE	18	Mode was not r.w.
		FE_FIND_ERROR	19	Failure during FILE search
		FE_INVALID_FNAME	20	Invalid Filename
		FE_INVALID_MEDIA	21	bad media
		FE_SECTOR_READ_FAIL	22	Sector Read fail
		FE_SECTOR_WRITE_FAIL	23	Sector write fail
Description	Returns the most recent error code or 0 if there were no errors.			
Example	e := file_Error(); // .			

2.14.2. file_Count(filename)

Syntax	<code>file_Count(filename);</code>	
Arguments	filename	
	filename	Name of the file(s) for the search (passed as a string)
Returns	Count	
	Count	Number of files that match the criteria.
Description	Returns number of files found that match the criteria. The wild card character '*' matches up with any combination of allowable characters and '?' matches up with any single allowable character.	
Example	<code>count := file_Count("*.4XE"); //Returns number of files with ".4XE".</code>	

2.14.3. file_Dir(filename)

Syntax	<code>file_Dir(filename);</code>	
Arguments	filename	
	filename	Name of the file(s) for the search (passed as a string)
Returns	Count	
	Count	Number of files found that match the criteria.
Description	Streams a string of file names that agree with the search key. Returns number of files found that match the criteria. The wild card character '*' matches up with any combination of allowable characters and '?' matches up with any single allowable character.	
Example	<code>count := file_Dir("*.4XE"); //Returns number of files with ".4XE".</code>	

2.14.4. file_FindFirst(fname)

Syntax	<code>file_FindFirst(fname);</code>	
Arguments	fname	
	fname	Name of the file(s) for the search (passed as a string)
Returns	Status	
	Status	1: If at least one file exists that satisfies the criteria. 0: If no file satisfies the criteria.
Description	Returns true if at least 1 file exists that satisfies the file argument. Wildcards are usually used so if file_FindFirst returns true, further tests can be made using file_FindNext(); to find all the files that match the wildcard class. Note that the stream behaviour is the same as file_Dir.	
Example	<pre>If (file_FindFirst("*.4XE")) Print("File Found") ; // . endif</pre>	

2.14.5. file_FindNext()

Syntax	file_FindNext();	
Arguments	None	
Returns	Status	
	Status	1: If more files exist that satisfy the criteria set in the file_FindFirstt(fname). 0: If no more files satisfy the criteria set in the file_FindFrist(fname)
Description	Returns true if more file exists that satisfies the file argument that was given for file_FindFirst. Wildcards must be used for file_FindFirst, else this function will always return zero as the only occurrence will have already been found. Note that the stream behaviour is the same as file_Dir.	
Example	<pre>while ((file_FindNext()) filecount++; wend</pre>	

2.14.6. file_Exists(fname)

Syntax	<code>file_Exists(fname);</code>	
Arguments	<code>fname</code>	
	<code>fname</code>	Name of the file for the search (passed as a string)
Returns	Status	
	Status	1: File found 0: File not found
Description	Tests for the existence of the file provided with the search key. Returns TRUE if found.	
Example	<pre>If (file_Exists("fill.4XE")) Print("File Found") ; // . endif</pre>	

2.14.7. file_Open(fname, mode)

Syntax	<code>file_Open(fname, mode);</code>	
Arguments	fname, mode	
	fname	Name of the file to be opened (passed as a string)
	mode	FILE_READ: 'r' FILE_WRITE: 'w' FILE_APPEND: 'a'
Returns	handle	
	handle	Returns handle if file exists. Sets internal file error number accordingly (0 if no errors).
Description	<p>Returns handle if file exists. The file "handle" that is created is now used as reference for "filename" for further file functions such as <code>file_Close(handle);</code>, etc. For FILE_WRITE and FILE_APPEND modes ('w' and 'a') the file is created if it does not exist. If the file is opened for append and it already exists, the file pointer is set to the end of the file ready for appending, else the file pointer will be set to the start of the newly created file.</p> <p>If the file was opened successfully, the internal error number is set to 0 (ie:- no errors) and can be read with the <code>file_Error();</code> function..</p> <p>For FILE_READ mode ('r') the file must exist else a null handle (0) is returned and the 'file not found' error number is set which can be read with the <code>file_Error();</code> function..</p> <p>Note: If a file is opened for write mode 'w', and the file already exists, the operation will fail. Unlike C and some other languages where the file will be erased ready for re-writing when opened for writing, 4DGL offers a simple level of protection that ensures that a file must be purposely erased before being re-written.</p>	
Example	<code>handle := file_Open("myfile.txt", 'r');</code>	

2.14.8. file_Close(handle)

Syntax	<code>file_Close(handle);</code>	
Arguments	handle	
	handle	the file handle that was created by <code>file_Open("fname")</code> which is now used as reference (handle) for "fname" for further file functions such as in this function to close the file.
Returns	Status	
	Status	1: File Closed. 0: File not closed.
Description	Returns TRUE if file closed, FALSE if not.	
Example	<code>res := file_Close(hndl);</code>	

2.14.9. file_Read(destination, size, handle)

Syntax	<code>file_Read(*destination, size, handle);</code>	
Arguments	destination, size, handle	
	destination	Destination memory buffer
	size	Number of bytes to be read
	handle	The handle that references the file to be read.
Returns	count	
	count	Returns the number of characters read.
Description	Reads the number of bytes specified by " size " from the file referenced by " handle " into a destination memory buffer.	
Example	<code>res := file_Read(memblock, 20, hnd11);</code>	

2.14.10. file_Seek(handle, HiWord, LoWord)

Syntax	<code>file_Seek(handle, HiWord, LoWord);</code>	
Arguments	handle, HiWord, LoWord	
	handle	The handle that references the file
	HiWord	Contains the upper 16bits of the memory pointer into the file
	LoWord	Contains the lower 16bits of the memory pointer into the file
Returns	Status	
	Status	Returns TRUE if ok, usually ignored
Description	Places the file pointer at the required position in a file that has been opened in 'r' (read) or 'a' (append) mode. In append mode, file_Seek does not expand a filesize, instead, the file pointer (handle) is set to the end position of the file, eg:- assuming the file size is 10000 bytes, file_Seek(handle, 0, 0x1234); will set the file position to 0x00001234 (byte position 4660) for the file handle, so subsequent data may be read from that position onwards with file_GetC(...), file_GetW(...), file_GetS(...), or an image can be displayed with file_Image(...). Conversely, file_PutC(...), file_PutW(...) and file_PutS(...) can write to the file at the position. A FE_EOF (end of file error) will occur if you try to write or read past the end of the file.	
Example	<code>res := file_Seek(hSource, 0x0000, 0x1234) ;</code>	

2.14.11. file_Index(handle, Hisize, LoSize, recordnum)

Syntax	<code>file_Index(handle, Hisize, LoSize, recordnum);</code>	
Arguments	handle, Hisize, LoSize, recordnum	
	handle	The handle that references the file
	Hisize	Contains the upper 16bits of the size of the file records.
	LoSize	Contains the lower 16bits of the size of the file records.
	recordnum	The index of the required record
Returns	Status	
	Status	Returns TRUE if ok, usually ignored
Description	Places the file pointer at the position in a file that has been opened in 'r' (read) or 'a' (append) mode. In append mode, file_Index does not expand a filesize, instead, the file pointer (handle) is set to the end position of the file, eg:- assuming the record size is 100 bytes, file_Index(handle, 0, 100, 22); will set the file position to 2200 for the file handle, so subsequent data may be read from that position onwards with file_GetC(...), file_GetW(...), file_GetS(...), or an image can be displayed with file_Image(...). Conversely, file_PutC(...), file_PutW(...) and file_PutS(...) can write to the file at the position. A FE_EOF (end of file error) will occur if you try to write or read past the end of the file.	
Example	<code>res := file_Index(hSource, 0, 100, 22) ;</code>	

2.14.12. file_Tell(handle, &HiWord, &LoWord)

Syntax	<code>file_Tell(handle, &HiWord, &LoWord);</code>	
Arguments	handle, &HiWord, &LoWord	
	handle	The handle that references the file
	HiWord	Contains the upper 16bits of the memory pointer into the file
	LoWord	Contains the lower 16bits of the memory pointer into the file
Returns	Status	
	Status	Returns TRUE if ok, usually ignored
Description	Returns the current value of the file pointer.	
Example	<code>res := file_Tell(hSource, &HIptr, &LOptr) ;</code>	

2.14.13. file_Write(*source, size, handle)

Syntax	<code>file_Write(*source, size, handle);</code>	
Arguments	source, size, handle	
	source	Source memory buffer.
	size	Number of bytes to be written.
	handle	The handle that references the file to write.
Returns	count	
	count	Returns the number of bytes written.
Description	Writes the number of bytes specified by "size" from the source buffer into the file referenced by "handle".	
Example	<code>res := file_Write(memblock, 20, hnd11);</code>	

2.14.14. file_Size(handle, &HiWord, &LoWord)

Syntax	<code>file_Size(handle, &HiWord, &LoWord);</code>	
Arguments	handle, HiWord, LoWord	
	handle	The handle that references the file.
	HiWord	Contains the upper 16bits of the file size.
	LoWord	Contains the lower 16bits of the file size.
Returns	Status	
	Status	Returns TRUE if ok, usually ignored.
Description	Reads the 32 bit file size and stores it into 2 variables	
Example	<code>res := file_Size(hSource, &sizeHi, &sizeLo);</code>	

2.14.15. file_Image(x, y, handle)

Syntax	<code>file_Image(x, y, handle);</code>	
Arguments	<code>x, y, handle</code>	
	x	X-position of the image to be displayed
	y	Y-position of the image to be displayed
	handle	The handle that references the file containing the image(s)
Returns	Returns a copy of the file_Error() error code	
Description	Display an image from the file stream at screen location specified by x, y(top left corner). If there is more than 1 image in the file, it can be accessed with file_Seek(...).	
Example	<code>file_Image(x, y, handle) ;</code>	

2.14.16. file_ScreenCapture(x, y, width, height, handle)

Syntax	file_ScreenCapture(x, y, width, height, handle);	
Arguments	x, y, width, height, handle	
	x	X-position of the image to be captured
	y	Y-position of the image to be captured
	width	Width of the area to be captured.
	height	Height of the area to be captured.
	handle	The handle that references the file to store the image(s)
Returns	Status	
	Status	Returns 0 if function successful.
Description	<p>Save an image of the screen shot to file at the current file position. The image can later be displayed with file_Image(...); The file may be opened in append mode to accumulate multiple images. Later, the images can be displayed with file_Seek(...). The image is saved from x, y (with respect to top left corner), and the capture area is determined by "width" and "height".</p>	
Example	<pre>file_Mount(); hFile := file_Open("test.img", 'a'); // open a file to save the image file_ScreenCapture(20,20,100,100, hFile); // save an area file_ScreenCapture(0,0,50,50, hFile); // (save another area) file_Close(hFile); // now close the file // and to display the saved area(s) hFile := file_Open("test.img", 'r'); // open the saved file file_Image(20,180, hFile); // display the image file_Image(150,180, hFile); // (display the next image) file_Close(hFile); file_Unmount(); // finished with file system</pre>	

2.14.17. file_PutC(char, handle)

Syntax	<code>file_PutC(char, handle);</code>	
Arguments	<code>char, handle</code>	
	char	Data byte about to be written.
	handle	The handle that references the file to be written to.
Returns	BytesWritten	
	BytesWritten	Returns the number of bytes written
Description	This function writes the byte specified by "char" to the file, at the position indicated by the associated file-position pointer and advances the pointer appropriately (incremented by 1). The file must be previously opened with 'w' (write) or 'a' (append) modes.	
Example	<code>file_PutC('A', hndl);</code>	

2.14.18. file_GetC(handle)

Syntax	<code>file_GetC(handle);</code>	
Arguments	handle	
	handle	The handle that references the file.
Returns	byte	
	byte	Returns the data byte read from the file.
Description	This function reads a byte from the file, at the position indicated by the associated file-position pointer and advances the pointer appropriately (incremented by 1). The file must be previously opened with 'r' (read) mode.	
Example	<code>mychar := file_GetC(hndl) ;</code>	

2.14.19. file_PutW(word, handle)

Syntax	<code>file_PutW(word, handle);</code>	
Arguments	word, handle	
	word	Data about to be written
	handle	The handle that references the file to be written to.
Returns	BytesWritten	
	BytesWritten	Returns the number of bytes written
Description	This function writes word sized (2 bytes) data specified by " word " to the file, at the position indicated by the associated file-position pointer and advances the pointer appropriately (incremented by 2). The file must be previously opened with 'w' (write) or 'a' (append) modes.	
Example	<code>file_PutW(0x1234, hndl);</code>	

2.14.20. file_GetW(handle)

Syntax	<code>file_GetW(handle);</code>	
Arguments	handle	
	handle	The handle that references the file.
Returns	Word	
	Word	Returns word sized data read from the file.
Description	This function reads a word (2 bytes) from the file, at the position indicated by the associated file-position pointer and advances the pointer appropriately (incremented by 2). The file must be previously opened with 'r' (read) mode.	
Example	<code>myword := file_GetW(hndl);</code>	

2.14.21. file_PutS(*source, handle)

Syntax	<code>file_PutS(*source, handle);</code>	
Arguments	<code>source, handle</code>	
	source	A pointer to the string to be written.
	handle	The handle that references the file to be written to.
Returns	<code>count</code>	
	count	Returns the number of characters written (excluding the null terminator).
Description	This function writes an ASCIIZ (null terminated) string from a buffer specified by " *source " to the file, at the position indicated by the associated file-position pointer and advances the pointer appropriately. The file must be previously opened with 'w' (write) or 'a' (append) modes.	
Example	<code>file_PutS(mystring, hndl);</code>	

2.14.22. file_GetS(*string, size, handle)

Syntax	<code>file_GetS(*string, size, handle);</code>	
Arguments	string, size, handle	
	string	Destination buffer
	size	The maximum number of bytes to be read from the file.
	handle	The handle that references the file.
Returns	Count	
	Count	Returns the number of characters read from file (excluding the null terminator)
Description	This function reads a line of text to a buffer (specified by " *string ") from a file at the current file position indicated by the associated file-position pointer and advances the pointer appropriately. Characters are read until either a newline or an EOF is received or until the specified maximum " size " is reached. In all cases, the string is null terminated. The file must be previously opened with 'r' (read) mode.	
Example	<code>res := file_GetS(mystring, 80, hndl);</code>	

2.14.23. file_Erase(fname)

Syntax	<code>file_Erase(fname);</code>	
Arguments	fname	
	fname	Name of the file to be erased
Returns	Status	
	Status	1: if successful 0: if unsuccessful
Description	This function erases a file on the disk. Note: If the function fails, the appropriate error number is set in <code>file_Error()</code> and will usually be error 19, "failure during FILE search".	
Example	<code>res := file_Erase("myfile.txt") ;</code>	

2.14.24. file_Rewind(handle)

Syntax	<code>file_Rewind(handle);</code>	
Arguments	handle	
	handle	The handle that references the file
Returns	Status	
	Status	Returns TRUE if ok, usually ignored
Description	Resets the file pointer to the beginning of a file that has been opened in 'r' (read), 'w', or 'a' (append) mode.	
Example	<code>res := file_Rewind(hSource); ;</code>	

2.14.25. file_LoadFunction(fname.4XE)

Syntax	<code>file_LoadFunction(fname.4XE);</code>	
Arguments	<code>fname.4XE</code>	
	<code>fname.4XE</code>	name of the 4DGL application program that is about to be loaded into RAM.
Returns	Pointer	
	Pointer	Returns a pointer to the memory allocation where the function has been loaded from file which can be then used as a function call.
Description	<p>Load a function or program from disk and return a function pointer to the allocation. The function can then be invoked just like any other function would be called via a function pointer. Parameters may be passed to it in a conventional way. The function may be discarded at any time when no longer required, thus freeing its memory resources.</p> <p>The loaded function can be discarded with <code>mem_Free(..)</code> Note that any pointer references passed to the child function may not include references to the parents DATA statements or any static string references. Any string or array information must be in the parents global or local memory space. The reason for this is that DATA statements and static strings are contained in the parents CODE segment, and cannot be accessed by the child process.</p> <p>Note: PmmC Rev 31 and above has an added feature where a parent can access the child global Variables when using <code>file_LoadFunction(fname.4XE)</code>.</p>	
Example1	<pre>var titlestring[20]; var textstring[20]; to(titlestring); putstr("My Window Title"); to(textstring); putstr("My Special Message"); popupWindow := file_LoadFunction("popupWindow1.4fn"); if(!popupWindow)goto LoadFunctionFailed;//could not load the function //then elsewhere in your program res := popupWindow(MYMODE,titlestring,textstring); if(res == QUIT_APPLICATION) goto exitApp; //Later in your program, when popupWindow is no longer required //for the application res := mem_Free(popupWindow); if(!res) goto FreeFunctionFailed; //should never happen if memory not //corrupted</pre>	
Example2	<pre>var fncHandle; //a var for a handle to sliders2.4dg var slidervals; //reference var to access global vars in sliders.4dg fncHandle := file_LoadFunction("sliders2.4xe"); // load the function slidervals := fncHandle&0x7FFF; // note that memory allocations for transient programs are biased with 8000h which must be removed. slidervals++; // note that all globals start at '1' slidervals[0] := 25; // set sliders to initial positions slidervals[1] := 20; slidervals[2] := 30; slidervals[3] := 15; slidervals[4] := 35; slidervals[5] := 20;</pre>	

```
slidervals[6] := 40;
slidervals[7] := 25;
slidervals[8] := 45;
slidervals[9] := 5;

r := fncHandle(); // activate the function

print("Return value = 0x", [HEX] r, "\n");

// print the values, they may have changed
print("Slider 1 ", slidervals[0], " Slider 2 ", slidervals[1], "\n");
print("Slider 3 ", slidervals[2], " Slider 4 ", slidervals[3], "\n");
print("Slider 5 ", slidervals[4], " Slider 6 ", slidervals[5], "\n");
print("Slider 7 ", slidervals[6], " Slider 8 ", slidervals[7], "\n");
print("Slider 9 ", slidervals[8], " Slider 10 ", slidervals[9], "\n");

mem_Free(fncHandle); // done with sliders, release its memory

Note: Refer to the complete Sample code, RUNDEMOS.4DG
```

2.14.26. file_Run(fname.4XE, arglistptr)

Syntax	file_Run(fname.4XE, arglistptr);	
Arguments	fname.4XE, arglistptr	
	fname.4XE	name of the 4DGL child program to be loaded into RAM and executed.
	arglistptr	pointer to the list of arguments to pass to the new program.
Returns	Value	
	Value	Returns the value from main in the called program.
Description	Any memory allocations in the main FLASH program are released, however, the stack and globals are maintained. func 'main' in the called program accepts the arguments, if any. If arglistptr is 0, no arguments are passed, else arglistptr points to an array, the first element containing the number of additional elements in the array which contain the arguments. The disk does not need to be mounted, file_Run automatically mounts the drive.	
Example	<pre>#inherit "4DGL_16bitColours.fnc" #inherit "FONT4.fnt" #constant MAXBUTTONS 30 // for now, maximum number of buttons we want // (also sets maximum number of files we can exec) #STACK 500 //stack must be large enough to be shared with called program #MODE RUNFLASH // This is a 'top down' main program and must be run from FLASH //-----// local global variables //----- // NB:- demo assigns all arrays to MAXBUTTONS. // The arrays could be dynamically assigned to minimise memory usage. // There is break even point between extra code and smallish arrays. var keyval; // 0 if no key pressed else 1-n var filenames; // pointer to byte array that holds the filenames var buttontexts[MAXBUTTONS]; // pointers into the filenames array //holds the filenames we use as button text var vButtonState[MAXBUTTONS]; //button state flag(bit 0 = up:down state) var vOldButtonState[MAXBUTTONS]; // OLD button state flags (bit 0 = up:down state) // (we keep 2 copies so we can test for a state change and only redraw when a state change occurs) var touchX1[MAXBUTTONS]; // touch regions for the buttons var touchY1[MAXBUTTONS]; var touchX2[MAXBUTTONS]; var touchY2[MAXBUTTONS]; var btnTextColor; // button text colour var btnBtnColor; // button background colour var buttoncount; // actual number of buttons created (set by number of *.4XE files we find on drive)</pre>	

```

var tempstr[20]; // general purpose string, 40 bytes
#DATA
byte fred 1,2,3,4,5,6,7,8,9,10,11,12
#END

/*=====
Redraw the button matrix. Only draw buttons that have changed state.
The top left corner of the button matrix is set with the xorg and yorg
parameters depending on the font and text string width, the button
matrix dynamically resizes.
Parameters:-
maxwidth = rhs from xorg (in pixels) to cause wrap at rhs
maxwidth = maximum matrix width (in pixel units)
buttoncount = number of buttons to display
font = FONT1 to FONT4
xorg:yorg = top left corner of button array
NB:- The touch detect matrix array is updated when any button changes
state.
When you need to draw the matrix for the first instance of the matrix,
you must
call with mode = 1 to instantiate the buttons.
call with mode = 0 for normal button action.
=====*/

func redraw(var bcount, var font, var xorg, var yorg, var maxwidth, var
mode )

var xgap, ygap, n, x1, y1, x2, y2;

xgap := 2;
ygap := 2;
x1 := xorg;
y1 := yorg;

// if first, set all the buttons to the up state
if (mode)
n := 0;
repeat
vButtonState[n]:=UP;
// set all the buttons to inverse state
vOldButtonState[n]:=DOWN;
// so we guarantee they are all drawn in the 'up' state (not pressed)
until(++n >= buttoncount);
endif

// check all the button states, if a change occurred, draw the new
button state and update the touch detect matrix array
n := 0;
repeat
// if the button state has changed
if ( vButtonState[n] != vOldButtonState[n])
vOldButtonState[n] := vButtonState[n];

// if we already have all the co-ordinates, use them
if (!mode)
x1 := touchX1[n];
y1 := touchY1[n];
x2 := touchX2[n];
y2 := touchY2[n];
endif

// draw the button
gfx_Button( vButtonState[n], x1, y1, btnBtnColor,
btnTextColor, font, 1, 1, buttontexts[n] );

// update the touch screen regions only during first build
if (mode)

```

```

        x2 := gfx_Get(RIGHT_POS);
        y2 := gfx_Get(BOTTOM_POS);

        touchX1[n] := x1;
        touchY1[n] := y1;
        touchX2[n] := x2;
        touchY2[n] := y2;

        // calculate next button position
        x1 := x2 + xgap;
        if (x1 >= xorg + maxwidth)
            x1 := xorg;
            y1 := y2 + ygap;
        endif
    endif
until (++n >= buttoncount);
endfunc

//=====
// do something with the key data
// In this example, we reconstitute the button name to a file name
// by appending ".4XE" and then call the file_Run command to
// run an application.
//=====
func sendkey()
    var p;

    p := buttontexts[keyval-1];
    to(tempstr); str_Printf(&p, "%s.4XE");

    txt_Set(TEXT_OPACITY, OPAQUE);
    txt_Set(FONT_ID , FONT4);
    txt_MoveCursor(3, 0);

    print ("          ");

    if(file_Exists(str_Ptr(tempstr)))
        touch_Set(TOUCH_DISABLE);           // disable the touch screen
        txt_Set(TEXT_COLOUR, ORANGE);
        print ("\rRUN: ", [STR] tempstr );// run the required program
        pause(500);
        gfx_Cls();
        file_Run(str_Ptr(tempstr),0); // just run the prog, no args
    else
        txt_Set(TEXT_COLOUR, RED);
        print ("\rFAULT: ", [STR] tempstr ); // run required program
        pause(1000);
    endif
endfunc

//=====
// convert the touch co-ordinates to a key value
// returns 0 if no key down else return index 1..n of button
//=====
func readKeys(var x, var y)

    var n, x1, y1, x2, y2, r;

    n := 0;
    r := 0;

    while (n < buttoncount && !r)
        x1 := touchX1[n];
        y1 := touchY1[n];
        x2 := touchX2[n];

```

```

        y2 := touchY2[n];
        n++;
        if (x >= x1 && x < x2 && y >= y1 && y < y2) r := n;
    wend

    return r;
endfunc

//=====
func main()

    var k, n, state, x, y;
    var p, s, w, f;
redo:
    w := 140;
    f := FONT4;
    btnTextColor := BLACK;
    btnBtnColor := LIGHTGREY;

    gfx_Cls();
    gfx_Set(BEVEL_WIDTH, 2);

    txt_Set(FONT_ID, FONT3);
    print("Simple test for file_Run(...);\n");
    print("Memory available = ",mem_Heap(),"\n");

    if(!file_Mount())
        putstr("Disk not mounted");
        while(!file_Mount());
    else
        putstr("Disk mounted\n");
    endif

    buttoncount := file_Count("*.4xe");
// count all the executable files on the drive
    print("4XE File count = ",buttoncount,"\n");

    n := buttoncount;        // k holds entry count
    if (!n)
        print("No 4XE executables\n");
// critical error, nothing to run!
        repeat forever
        endif

        filenames := mem_AllocZ(n*13);
// allocate a buffer for the filenames
        if(!filenames)
            print("Out of memory\n");
// critical error, could not allocate buffer
            repeat forever
            endif

            to(filenames); file_Dir("*.4xe");
// load the filenames array

            p := str_Ptr(filenames);    // point to the string

//assign array of string pointers and truncate filename extensions
            n := 0;
            while ( n < buttoncount )
                buttontexts[n++] := p;    // save pointer to the string
                p:=str_Find ( &p , "." ); // find end of required string
                str_PutByte(p+,'\0');    // change '.' to \0
                p := p + 4;              // skip over "4XE\n"
            wend

            touch_Set(TOUCH_ENABLE);    // enable the touch screen

```

```

        redraw(buttoncount, f, 10, 80, w, 1);
// draw buttons for the first time

        // now just stay in a loop
        repeat
            state := touch_Get(TOUCH_STATUS); // get touchscreen status
            x := touch_Get(TOUCH_GETX);
            y := touch_Get(TOUCH_GETY);

            if(state == TOUCH_PRESSED) // if there's a press
                if (keyval := readKeys(x, y))
                    vButtonState[keyval-1] := DOWN;
// put button in DOWN state
                    redraw(buttoncount, f, 10, 80, w, 0);
// draw any button down states
                endif
            endif

            if(state == TOUCH_RELEASED)
// if there's a release
                if (keyval)
                    vButtonState[keyval-1] := UP;
// restore the buttons UP state
                    redraw(buttoncount, f, 10, 80, w, 0);
// draw any button up states
                    sendkey();
// do something with the key data
                    keyval := 0;
// because prog(main prog) gave up all its allocations for file_Exec,
// we have lost our file mount info and the directory list so we must
// re-establish these to be able to continue. A better approach to
// ensure total stability for the main program is to reset the system
                    // with SystemReset()
                    //=====
                    // systemReset() // restart the main program
                    // or
                    goto redo; // re-mount disk, reload filenames
                    //=====

                endif
            endif

        forever

            // mem_Free(filenamees);
            // no need to release buffer, this prog is in flash and never
            // exits.....
            // file_Unmount(); // ditto

        endfunc
//=====

```

2.14.27. file_Exec(fname.4XE, arglistptr)

Syntax	<code>file_Exec(fname.4XE, arglistptr);</code>	
Arguments	<code>fname.4XE, arglistptr</code>	
	fname.4XE	name of the 4DGL child program to be loaded into RAM and executed.
	arglistptr	pointer to the list of arguments to pass to the new program or 0 if no arguments.
Returns	Value	
	Value	Returns the value from main in the called program.
Description	This function is similar to file_Run , however, the main program in FLASH retains all memory allocations (eg file buffers, memory allocated with mem_Alloc etc)	
Example	<code>file_Exec("bounce.4xe", 0) ;</code>	

2.14.28. file_LoadImageControl(fname1, fname2, mode)

Syntax	file_LoadImageControl(fname1, fname2, mode);													
Arguments	fname1, fname2, mode													
	fname1	the control list filename "*.dat". Created from Graphics Composer.												
	fname2	the image filename "*.gci". Created from Graphics Composer.												
	mode	<p>mode 0 :</p> <p>It is assumed that there is a graphics file with the file extension "fname2.gci". In this case, the images have been stored in a FAT16 file concurrently, and the offsets that are derived from the "fname1.dat" file are saved in the image control so that the image control can open the file (*.gci) and use file_Seek(..) to get to the position of the image which can then automatically be displayed using file_Image(xpos, ypos, hSource).</p> <p>Mode 0 builds the image control quickly as it only scans the *.dat file for the file offsets and saves them in the relevant entries in the image control. The penalty is that images take longer to find when displayed due to file_Seek(..) overheads.</p> <p>mode 1 :</p> <p>It is assumed that there is a graphics file with the file extension "fname2.gci". In this case, the images have been stored in a FAT16 file concurrently, and the offset of the images are saved in the image control so that image file (*.gci) can be mapped to directly. The absolute cluster/sector is mapped so file seek does not need to be called internally. This means that there is no seek time penalty, however, the image list takes a lot longer to build, as all the seeking is done at control build time.</p> <p>Mode 2 :</p> <p>Not implemented yet.</p>												
Returns	Status													
	Status	Returns a handle (pointer to the memory allocation) to the image control list that has been created. Returns NULL if function fails.												
Description	<p>Reads a control file to create an image list.</p> <p>When an image control is loaded, an array is built in ram. It consists of a 6 word header with the following entries as defined by the constants:</p> <table border="0"> <tr> <td>IMG_COUNT</td> <td>0</td> </tr> <tr> <td>IMG_ENTRYLEN</td> <td>1</td> </tr> <tr> <td>IMG_MODE</td> <td>2</td> </tr> <tr> <td>IMG_GCI_FILENAME</td> <td>3</td> </tr> <tr> <td>IMG_DAT_FILENAME</td> <td>4</td> </tr> <tr> <td>IMG_GCIFILE_HANDLE</td> <td>5</td> </tr> </table> <p>No images are stored in FLASH or RAM, the image control holds the index values for the</p>		IMG_COUNT	0	IMG_ENTRYLEN	1	IMG_MODE	2	IMG_GCI_FILENAME	3	IMG_DAT_FILENAME	4	IMG_GCIFILE_HANDLE	5
IMG_COUNT	0													
IMG_ENTRYLEN	1													
IMG_MODE	2													
IMG_GCI_FILENAME	3													
IMG_DAT_FILENAME	4													
IMG_GCIFILE_HANDLE	5													

absolute storage positions on the uSD card for RAW mode, or the cluster/sector position for formatted FAT16 mode.

When an image control is no longer required, the memory can be released with:

```
mem_Free(MyImageControlHandle);
```

Example

```
#inherit "4DGL_16bitColours.fnc"

#constant OK 1
#constant FAIL 0

var p; // buffer pointer
var img; // handle for the image list
var n, exit, r;

//-----
// return true if screen touched, also sets ok flag
func CheckTouchExit()
    return (exit := (touch_Get(TOUCH_STATUS) == TOUCH_PRESSED)); //
if there's a press, exit
endfunc
//-----

func main()

    gfx_Cls();
    txt_Set(FONT_ID, FONT2);
    txt_Set(TEXT_OPACITY, OPAQUE);

    touch_Set(TOUCH_ENABLE); // enable the touch screen

    print("heap=", mem_Heap(), " bytes\n"); // show the heap size

    r := OK; // return value
    exit := 0;

    if (!file_Mount())
        print("File error ", file_Error());
        while(!CheckTouchExit());
// just hang if we didnt get the image list
    r := FAIL;
    goto quit;
endif

    print ("WAIT...building image list\n");

// slow build, fast execution, higher memory requirement
    img := file_LoadImageControl("GFX2DEMO.dat", "GFX2DEMO.gci", 1);
// build image control, returning a pointer to structure allocation

    if (img)
        print("image control=", [HEX] img, "\n");
// show the address of the image control allocation
    else
        putstr("Failed to build image control...\n");
        while(CheckTouchExit() == 0);
// just hang if we didnt get the image list
    r := FAIL;
    goto quit;
endif

    print ("Loaded ", img[IMG_COUNT], " images\n");
    print ("\nTouch and hold to exit...\n");
```

```
    pause(2000);  
  
    pause(3000);  
    gfx_Cls();  
  
    repeat  
        n := 0;  
  
        while(n < img[IMG_COUNT] && !exit) // go through all images  
            CheckTouchExit();           // if there's a press, exit  
  
            img_SetPosition( img, n, (ABS(RAND() % 240)), (ABS(RAND() %  
320))); // spread out the images  
  
            n++;  
  
        wend  
  
        img_Show(img, ALL);           // update the entire control in 1 hit  
  
    until(exit);  
quit:  
    mem_Free(img);           // release the image control  
    file_Unmount();         // (program must release all resources)  
  
    return r;  
  
endfunc  
//=====
```

2.14.29. file_Mount()

Syntax	<code>file_Mount();</code>	
Arguments	None	
Returns	Status	
	Status	Returns true if successful.
Description	Starts up the FAT16 disk file services and allocates a small 20 byte control block for subsequent use. When you open a file using <code>file_Open(..)</code> , a further 512 + 44 = 556 bytes are attached to the FAT16 file control block. When you close a file using <code>file_Close(..)</code> , the 556 byte allocation is released leaving the 20 byte file control block. The <code>file_Mount()</code> function must be called before any other FAT16 file related functions can be used. The control block and all FAT16 file resources are completely released with <code>file_Unmount()</code> .	
Example	<pre> if(!file_Mount()) repeat putstr("Disk not mounted"); pause(200); gfx_Cls(); pause(200); until(file_Mount()); endif </pre>	

2.14.30. file_Unmount()

Syntax	<code>file_Unmount();</code>
Arguments	None
Returns	None
Description	Release any buffers for FAT16 and unmount the Disk File System. This function is to be called to close the FAT16 file system.
Example	<code>file_Unmount(); //</code>

2.14.31. file_PlayWAV(fname)

Syntax	<code>file_PlayWAV(fname);</code>	
Arguments	<code>fname</code>	
	<code>fname</code>	Name of the wav file to be opened and played
Returns	<code>value</code>	
	<code>value</code>	<p>If there are no errors, returns number of blocks to play (1 to 32767)</p> <p>If errors occurred, the following is returned</p> <p>6 : cant play this rate</p> <p>5 : no data chunk found in first rsector</p> <p>4 : no format data</p> <p>3 : no wave chunk signature</p> <p>2 : bad wave file format</p> <p>1 : file not found</p>
Description	Open the wav file, decode the header to set the appropriate wave player parameters and set off the playing of the file as a background process. See "Sound Control Functions" for additional play control functions.	
Example	<pre>print("\nding.wav\n"); for(n:=0; n<45; n++) pitch := NOTES[n]; print([UDEC] pitch, "\r"); snd_Pitch(pitch); file_PlayWAV("ding.wav"); while(snd_Playing()); //pause(500); next</pre>	

2.15. Sound Control Functions

Summary of Functions in this section:

- Snd_Volume(var)
- Snd_Pitch(pitch)
- Snd_BufSize(var)
- Snd_Stop()
- Snd_Pause()
- Snd_Continue()
- Snd_Playing()

2.15.1. Snd_Volume(var)

Syntax	Snd_Volume(var);	
Arguments	var	
	var	sound playback volume
	The arguments can be a variable, array element, expression or constant	
Returns	None	
Description	Set the sound playback volume. Var must be in the range from 8 (min volume) to 127 (max volume). If var is less than 8, volume is set to 8, and if var > 127 it is set to 127.	
Example	<code>snd_Volume(127) ; // Set Volume to maximum</code>	

2.15.2. Snd_Pitch(pitch)

Syntax	Snd_Pitch(pitch);	
Arguments	pitch	
	pitch	Sample's playback rate. Minimum is 4KHz. Range is, 4000 – 65535.
	The arguments can be a variable, array element, expression or constant	
Returns	value	
	value	Returns sample's original sample rate.
Description	Sets the samples playback rate to a different frequency. Setting pitch to zero restores the original sample rate.	
Example	<code>snd_Pitch(7000); //Play the wav file with a sample frequency of 7KHz.</code>	

2.15.3. Snd_BufSize(var)

Syntax	Snd_BufSize(var);	
Arguments	var	
	var	Specifies the buffer size. 0 = 1024 bytes (default) 1 = 2048 bytes 2 = 4096 bytes
	The arguments can be a variable, array element, expression or constant	
Returns	None.	
Description	Specify the a memory chunk size for the wavefile buffer, default size 1024 bytes. Depending on the sample size, memory constraints, and the sample quality, it may be beneficial to change the buffer size from the default size of 1024 bytes. This function is for control of a wav buffer, see the file_PlayWAV(..) ; function	
Example	<code>snd_BufSize(1); // allocate a 2k wav buffer</code>	

2.15.4. snd_Stop()

Syntax	<code>snd_Stop();</code>
Arguments	None
Returns	None
Description	Stop any sound that is currently playing, releasing buffers and closing any open wav file. This function is for control of a wav buffer, see the <code>file_PlayWAV(..)</code> ; function
Example	<code>snd_Stop(); //</code>

2.15.5. snd_Pause()

Syntax	<code>snd_Pause();</code>
Arguments	None
Returns	None
Description	Pause any sound that is currently playing. This function is for control of a wav buffer, see the <code>file_PlayWAV(..)</code> ; function
Example	<code>snd_Pause(); //</code>

2.15.6. snd_Continue()

Syntax	<code>snd_Continue();</code>
Arguments	None
Returns	None
Description	Resume any sound that is currently paused by <code>snd_Pause</code> . This function is for control of a wav buffer, see the <code>file_PlayWAV(..)</code> ; function
Example	<code>snd_Continue(); //</code>

2.15.7. snd_Playing()

Syntax	<code>snd_Playing();</code>	
Arguments	None	
Returns	value	
	value	Number of 512 byte blocks to go.
Description	Returns 0 if sound has finished playing, else return number of 512 byte blocks to go. This function is for control of a wav buffer, see the <code>file_PlayWAV(..)</code> ; function	
Example	<pre>count := snd_Playing(); //</pre>	

2.16. String Class Functions

Summary of Functions in this section:

- `str_Ptr(&var)`
- `str_GetD(&ptr, &var)`
- `str_GetW(&ptr, &var)`
- `str_GetHexW(&ptr, &var)`
- `str_GetC(&ptr, &var)`
- `str_GetByte(ptr)`
- `str_GetWord(ptr)`
- `str_PutByte(ptr, val)`
- `str_PutWord(ptr, val)`
- `str_Match(&ptr, *str)`
- `str_MatchI(&ptr, *str)`
- `str_Find(&ptr, *str)`
- `str_FindI(&ptr, *str)`
- `str_Length(ptr)`
- `str_Printf(&ptr, *format)`
- `str_Cat(&destination, &Source)`
- `str_CatN(&ptr, str, count)`
- `str_String(char, count)`
- `str_ByteMove(src, dest, count)`
- `str_Copy(dest, src)`
- `str_CopyN(dest, src, count)`

2.16.1. str_Ptr(&var)

Syntax	str_Ptr(&var);	
Arguments	var	
	var	Pointer to string buffer
Returns	Pointer	
	Pointer	Returned value is the byte pointer to string buffer.
Description	Return a byte pointer to a word region.	
Example	<pre> var buffer[100]; // 200 character buffer for a source string var p; // string pointer var n; var vars[3]; // for our results func main() to(buffer); print("0x1234 0b10011001 12345 abacus"); p := str_Ptr(buffer); //raise string pointer for the string functions while(str_GetW(&p, &vars[n++]) != 0); // read all the numbers till we //get a non number print(vars[0], "\n", vars[1], "\n", vars[2], "\n"); // print them out endfunc </pre>	

2.16.2. str_GetD(&ptr, &var)

Syntax	<code>str_GetD(&ptr, &var);</code>	
Arguments	&ptr, &var	
	ptr	Byte pointer to string.
	var	Destination for our result.
Returns	Status	
	Status	
Description	Convert number in a string to DWORD (myvar[2]). NB:- The address of the pointer must be passed so the function can advance it if required.	
Example	<pre> var buffer[100]; // 200 character buffer for a source string var p; // string pointer var n; var vars[6]; // for our results func main() to(buffer); print("100000 200000 98765432 abacus"); p := str_Ptr(buffer); // raise a string pointer so we can use the // string functions while(str_GetD(&p, &vars[n]) != 0) n:=n+2; //read all the numbers //till we get a non number print([HEX4] vars[1], ":" , [HEX4] vars[0], "\n"); // show the longs as hex numbers print([HEX4] vars[3], ":" , [HEX4] vars[2], "\n"); print([HEX4] vars[5], ":" , [HEX4] vars[4], "\n"); endfunc </pre>	

2.16.3. str_GetW(&ptr, &var)

Syntax	<code>str_GetW(&ptr, &var);</code>	
Arguments	&ptr, &var	
	ptr	byte pointer to string.
	var	destination for our result.
Returns	Status	
	Status	Returns TRUE if function succeeds, advancing ptr.
Description	Convert number in a string to WORD (myvar). NB:- The address of the pointer must be passed so the function can advance it if required.	
Example	<pre> var buffer[100]; // 200 character buffer for a source string var p; // string pointer var n; var vars[3]; // for our results func main() to(buffer); print("0x1234 0b10011001 12345 abacus"); p := str_Ptr(buffer); // raise a string pointer so we can use the // string functions while(str_GetW(&p, &vars[n++]) != 0); // read all the numbers till // we get a non number print(vars[0], "\n", vars[1], "\n", vars[2], "\n"); // print them out str_Printf (&p, "%s\n"); // numbers extracted, now just print // remainder of string endfunc </pre>	

2.16.4. str_GetHexW(&ptr, &var)

Syntax	<code>str_GetHexW(&ptr, &var);</code>	
Arguments	&ptr, &var	
	ptr	byte pointer to string
	var	destination for our result.
Returns	Status	
	Status	Returns TRUE if function succeeds, advancing ptr
Description	Convert hex number in a string to WORD (myvar). This function is for extracting 'raw' hex words with no "0x" prefix. Note: The address of the pointer must be passed so the function can advance it if required.	
Example	<pre> var buffer[100]; // 200 character buffer for a source string var p; // string pointer var n; var vars[4]; // for our results func main() to(buffer); print("1234 5678 9 ABCD"); p := str_Ptr(buffer); // raise a string pointer so we can use the // string functions while(str_GetHexW(&p, &vars[n++]) != 0); // read all the hex numbers // till we get a non number print(vars[0], "\n", vars[1], "\n" , vars[2], "\n", vars[3], "\n"); endfunc </pre>	

2.16.5. str_GetC(&ptr, &var)

Syntax	<code>str_GetC(&ptr, &var);</code>	
Arguments	&ptr, &var	
	ptr	Byte pointer to string.
	var	Destination for our result.
	The arguments can be a variable, array element, expression or constant	
Returns	Status	
	Status	Returns TRUE if function succeeds, advancing ptr.
Description	<p>Get next valid ascii char in a string to myvar. NB:- The address of the pointer must be passed so the function can advance it if required. The function returns 0 if end of string reached. Used for extracting single characters from a string.</p>	
Example	<pre> var p; // string pointer var n; var char; var buffer[100]; // 200 character buffer for a source string func main() to(buffer); print("Quick Brown Fox"); p := str_Ptr(buffer); // raise a string pointer so we can use the //string functions while(str_GetC(&p, &char)) print("p=",p," char is", [CHR] char); // print characters wend print("End of string"); endfunc </pre>	

2.16.6. str_GetByte(ptr)

Syntax	str_GetByte(ptr);	
Arguments	ptr	
	ptr	Address of byte array or string.
Returns	byte	
	byte	Returns the byte value at pointer location.
Description	Get a byte to myvar. Similar to "PEEKB" in basic. It is not necessary for byte pointer ptr to be word aligned	
Example	<pre> var buffer[100]; // 200 character buffer for a source string var n, p; func main() to(buffer); print("Testing 1 2 3"); p := str_Ptr(buffer); // get a byte pointer from a word region n := 0; while (n <= str_Length(buffer)) print([HEX2] str_GetByte(p + n++), " "); // print all the chars hex // values wend endfunc </pre>	

2.16.7. str_GetWord(ptr)

Syntax	str_GetWord(ptr);	
Arguments	ptr	
	ptr	Byte pointer
Returns	Word	
	Word	Returns the word at pointer location.
Description	Get a word to myvar. Similar to PEEKW in basic. It is not necessary for byte pointer ptr to be word aligned	
Example	<pre> var p; // string pointer var buffer[10]; // array for 20 bytes func main() p := str_Ptr (buffer); // raise a string pointer str_PutWord (p+3, 100); // 'poke' the array str_PutWord (p+9, 200); str_PutWord (p+12, 400); print(str_GetWord(p + 3), "\n"); // 'peek' the array print(str_GetWord(p + 9), "\n"); print(str_GetWord(p + 12), "\n"); endfunc </pre>	

2.16.8. str_PutByte(ptr, val)

Syntax	<code>str_PutByte(ptr, val);</code>	
Arguments	<code>ptr, val</code>	
	ptr	byte pointer to string
	val	byte value to insert.
Returns	None	
Description	Put a byte value into a string buffer at ptr Similar to "POKEB" in basic It is not necessary for byte pointer ptr to be word aligned	
Example	<pre> var buffer[100]; // 200 character buffer for a source string var p; // string pointer func main() p := str_Ptr(buffer); // raise a string pointer so we can use the // string functions str_PutByte(p + 3, 'A'); // store some values str_PutByte(p + 4, 'B'); // store some values str_PutByte(p + 5, 'C'); // store some values str_PutByte(p + 7, 'D'); // store some values str_PutByte(p + 7, 0); // string terminator fprintf(vars[0], "\n", vars[1], "\n", vars[2], "\n"); // print them out p := p + 3; // offset to where we placed the chars fprintf(&p, "%s\n"); // print the result // nb, also, understand that the core print service // assumes a word aligned address so it starts at pos 4 // print([STR] &buffer[2]); endfunc </pre>	

2.16.9. str_PutWord(ptr, val)

Syntax	<code>str_PutWord(ptr, val);</code>	
Arguments	Ptr, val	
	ptr	byte pointer
	val	value to store.
Returns	None	
Description	Put a word value into a byte buffer at ptr, similar to "POKEW" in basic. It is not necessary for byte pointer ptr to be word aligned	
Example	<pre> var p; // string pointer var numbers[10]; // array for 20 bytes func main() p := str_Ptr (numbers); // raise a string pointer str_PutWord (p+3, 100); // 'poke' the array with some numbers str_PutWord (p+9, 200); str_PutWord (p+12, 400); print(str_GetWord(p + 3), "\n"); // 'peek' the array print(str_GetWord(p + 9), "\n"); print(str_GetWord(p + 12), "\n"); endfunc </pre>	

2.16.10. str_Match(&ptr, *str)

Syntax	<code>str_Match(&ptr, *str);</code>	
Arguments	<code>ptr, str</code>	
	<code>ptr</code>	Address of byte pointer to string buffer.
	<code>str</code>	Pointer string to match.
Returns	Value	
	Value	Returns 0 if no match, else advance ptr to the next position after the match and returns that value.
Description	<p>Case Sensitive match.</p> <p>Compares the string at position ptr in a string buffer to the string str, skipping over any leading spaces if required. If a match occurs, ptr is advanced to the first position past the match, else ptr is not altered.</p> <p>NB:- The address of the pointer must be passed so the function can advance it if required.</p>	
Example	<pre>var buffer[100]; // 200 character buffer for a source string var p, q; // string pointers var n; func main() to(buffer); print(" volts 240 ");// string to parse p := str_Ptr(buffer); // string pointer to be used // with string functions q := p; if (n := str_Match(&p, "volts")) str_Printf (&p, "%s\n"); // print remainder of string else print ("not found\n"); endif print ("startpos=" , q , "\nfindpos=" , n , "\nendpos=" , p); endfunc</pre>	

2.16.11. str_Matchl(&ptr, *str)

Syntax	<code>str_Matchl(&ptr, *str);</code>	
Arguments	<code>ptr, str</code>	
	<code>ptr</code>	Address of byte pointer to string buffer.
	<code>str</code>	Pointer string to match.
Returns	Value	
	Value	Returns 0 if no match, else advance ptr to the next position after the match and returns that value.
Description	<p>Case Insensitive match.</p> <p>Compares the string at position ptr in a string buffer to the string str, skipping over any leading spaces if required. If a match occurs, ptr is advanced to the first position past the match, else ptr is not altered.</p> <p>NB:- The address of the pointer must be passed so the function can advance it if required.</p>	
Example	<pre>var buffer[100]; // 200 character buffer for a source string var p, q; // string pointers var n; func main() to(buffer); print("The sun rises in the East");// string to parse p := str_Ptr(buffer); // string pointer to be used // with string functions q := p; if (n := str_Match(&p, "the")) // Will find the first "The" str_Printf (&p, "%s\n"); // print remainder of string else print ("not found\n"); endif print ("startpos=" , q , "\nfindpos=" , n , "\nendpos=" , p); endfunc</pre>	

2.16.12. str_Find(&ptr, *str)

Syntax	<code>str_Find(&ptr, *str);</code>	
Arguments	ptr, str	
	ptr	Byte pointer to string buffer.
	str	String to find.
Returns	Value	
	Value	Returns 0 if not found. Returns the position of the find if successful.
Description	Case Sensitive. Searches for string str in string buffer pointed to by ptr. NB:- The pointer ptr is not altered.	
Example	<pre> var buffer[100]; // 200 character buffer for a source string var p; // string pointer var n; var strings[4]; // for our test strings func main() txt_Set (FONT_ID, FONT2); strings[0] := "useful" ; strings[1] := "string" ; strings[2] := "way" ; strings[3] := "class" ; to(buffer); print ("and by the way, the string class is rather useful "); p := str_Ptr(buffer); // raise a string pointer so we can use the string functions p := p + 13; // offset into the buffer a little so we don't see word "way" print("p=" , p , "\n\n"); // show the start point of our search n := 0; while (n < 4) print("\" , [STR] strings[n] , "\" is at pos " , str_Find (&p , strings[n++]) , "\n"); wend print ("\nNOTE: p is unchanged, p=" , p);//note that p is unchanged endfunc </pre>	

2.16.13. str_Findl(&ptr, *str)

Syntax	<code>str_Findl(&ptr, *str);</code>	
Arguments	ptr, str	
	ptr	Byte pointer to string buffer.
	str	String to find.
Returns	Value	
	Value	Returns 0 if not found. Returns the position of the find if successful.
Description	Case Insensitive. Searches for string str in string buffer pointed to by ptr. NB:- The pointer ptr is not altered.	
Example	<pre> var buffer[100]; // 200 character buffer for a source string var p; // string pointer var n; var strings[4]; // for our test strings func main() txt_Set (FONT_ID, FONT2); strings[0] := "useful" ; strings[1] := "string" ; strings[2] := "way" ; strings[3] := "class" ; to(buffer); print ("and by the way, the string class is rather useful "); p := str_Ptr(buffer); // raise a string pointer so we can use the string functions p := p + 13; // offset into the buffer a little so we don't see word "way" print("p=" , p , "\n\n"); // show the start point of our search n := 0; while (n < 4) print("\" , [STR] strings[n] , "\" is at pos " , str_Find (&p , strings[n++]) , "\n"); wend print ("\nNOTE: p is unchanged, p=" , p);//note that p is unchanged endfunc </pre>	

2.16.14. str_Length(ptr)

Syntax	str_Length(ptr);	
Arguments	ptr	
	ptr	pointer to string buffer.
Returns	Value	
	Value	Returns String length.
Description	Returns the length of a string excluding terminator.	
Example	<pre> var a; var b; var c[40]; // 80 character buffer for a source string var pa, pc; //These will be String pointers to a and c[] func main() a := mem_Alloc(200); // allocate a dynamic buffer full of random data mem_Set (a, 'X', 200); // fill it full of 'X's pa := str_Ptr(a); // raise a string pointer str_PutByte(pa+20,0); //Now stick a string terminator in the array //Change the 20 to be between 0 and 199 b := "A string constant" ; // b is a pointer to a string constant to (c); print ("An 'ASCIIZ' string is terminated with a zero"); pc := str_Ptr(c); // raise a string pointer so we can use the // string functions print ("a length:", str_Length(pa), "\n"); // show length of the // dynamic buffer print ("b length:", str_Length(b), "\n"); // show length of the // static string print ("c length:", str_Length(pc), "\n"); // show length of the // 're-directed' string mem_Free (a); // test is over, free up the memory repeat forever endfunc </pre>	

2.16.15. str_Printf(&ptr, *format)

Syntax	<code>str_Printf(&ptr, *format);</code>	
Arguments	Ptr, format	
	ptr	Byte pointer to the input data (structure).
	format	<p>Format string.</p> <p>Note: The address of the pointer must be passed so the function can advance it as required.</p> <p>Note: The format specifier string can be a string pointer, allowing dynamic construction of the printing format.</p> <p>Format Specifiers:</p> <p>%c character</p> <p>%s string of characters</p> <p>%d signed decimal</p> <p>%ld long decimal</p> <p>%u unsigned decimal</p> <p>%lu long unsigned decimal</p> <p>%x hex byte</p> <p>%X hex word</p> <p>%lX hex long</p> <p>%b binary word</p> <p>%lb long binary word</p> <p>* indirection prefix (placed after '%' to specify indirect addressing)</p> <p>(number) width description (use between '%' and format specifier to set the field width).</p> <p>Note: If (number) is preceded by 0, the result is Left-pads with zeroes (0) instead of spaces.</p>
Returns	Pointer	
	Pointer	Returns the position of last extraction point. This is useful for processing by other string functions.
Description	This function prints a formatted string from elements derived from a structured byte region. There is only one input argument, the byte region pointer ptr which is automatically advanced as the format specifier string is processed. The format string is similar to the C language, however, there are a few differences, including the addition of the indirection token * (asterix).	
Example	<pre>var buffer[100]; // 200 character buffer for a source string var p, q; // string pointers var n; var m[20]; // for our structure example var format; // a pointer to a format string func main() var k;</pre>	

```
// string print example
to (buffer); print ( "\nHELLO WORLD" );

q := str_Ptr (buffer); // raise a string pointer so we can use the
                        // string functions
p := q;
str_Printf ( &p , "%8s" ); // only prints first 8 characters of
                        // string

putch ('\n');          // new line

p := q;
k := str_Printf ( &p , "%04s" ); // prints 4 leading spaces before
                        // string

putch ('\n'); // new line
print ( k );  // if required, the return value points to the last
              // source position and is returned for processing by
              // other string functions

// print structure elements example, make a demo structure

n := 0;
m[n++] := "Mrs Smith" ;
m[n++] := 200 ;
m[n++] := 300 ;
m[n++] := 0xAA55 ;
m[n++] := 500 ;

// make a demo format control string

format := "%*s\n%d\n%d\n%016b\n%04X" ; // format string for printing
                                         // structure m

// print the structure in the required format

p := str_Ptr (m);          // point to structure m
str_Printf (&p, format);   // use the format string to print the
                        // structure

endfunc
```

2.16.16. str_Cat(&destination, &source)

Syntax	<code>str_Cat(&destination, &source);</code>	
Arguments	destination, source	
	destination	Destination string address
	source	Source string address
Returns	Pointer	
	Pointer	Returns pointer to the destination.
Description	Appends a copy of the source string to the destination string. The terminating null character in destination is overwritten by the first character of source, and a new null-character is appended at the end of the new string formed by the concatenation of both in destination.	
Example	<code>str_Cat(&buf, "Hello"); // Will append buf with "Hello".</code>	

2.16.17. str_CatN(&ptr, str, count)

Syntax	<code>str_CatN(&ptr, str, count);</code>	
Arguments	<code>ptr, str, count</code>	
	ptr	Destination string address
	str	Source string address
	count	Number of characters to be concatenated.
Returns	Pointer	
	Pointer	Returns pointer to the destination.
Description	<p>The number of characters copied is limited by "count".</p> <p>The terminating null character in destination is overwritten by the first character of source, and a new null-character is appended at the end of the new string formed by the concatenation of both in destination.</p>	
Example	<code>str_CatN(&buf, "Monday", 3); // Concatenate "Mon" with the buf.</code>	

2.16.18. str_ByteMove(src, dest, count)

Syntax	<code>str_ByteMove(src, dest, count);</code>	
Arguments	<code>src, dest, count</code>	
	src	points to byte aligned source.
	dest	points to byte aligned destination.
	count	Number of bytes to transfer.
Returns	Pointer	
	Pointer	Returns a pointer to the end of the destination (which is "dest" + "count").
Description	Copy bytes from "src" to "dest", stopping only when "count" is exhausted. No terminator is appended, it is purely a byte copy, and any zeroes encountered will also be copied.	
Example	<pre> var src, dest, mybuf1[10], mybuf2[10]; // string pointers and two 20 byte buffers to(mybuf1); putstr("TESTING 123"); src := strPtr(mybuf1); dest := str_Ptr(mybuf2); src += 6; // move src pointer to "G 123" str_ByteMove(src, dest, 6); // move to second buffer (including the zero terminator) putstr(mybuf2); // print result nextpos := str_ByteMove(s, d, 100); </pre>	

2.16.19. str_Copy(dest, src)

Syntax	<code>str_Copy(dest, src);</code>	
Arguments	<code>dest, src</code>	
	dest	points to byte aligned destination.
	src	points to byte aligned source.
Returns	Pointer	
	Pointer	Returns a pointer to the 0x00 string terminator at the end of "dest" (which is "dest" + str_Length(src);).
Description	Copy a string from "src" to "dest", stopping only when the end of source string "src" is encountered (0x00 terminator). The terminator is always appended, even if "src" is an empty string.	
Example	<code>nextplace := str_Copy(d, s);</code>	

2.16.20. str_CopyN(dest, src, count)

Syntax	<code>str_CopyN(dest, src, count);</code>	
Arguments	dest, src, count	
	dest	points to byte aligned destination.
	src	points to byte aligned source.
	count	Maximum number of bytes to copy.
Returns	Pointer	
	Pointer	Returns a pointer to the 0x00 string terminator at the end of "dest" (which is "dest" + str_Length(src);).
Description	Copy a string from "src" to "dest", stopping only when "count" is exhausted, or end of source string "str" is encountered (0x00 string terminator). The terminator is always appended, even if "count" is zero, or "src" is a null string.	
Example	<code>nextplace := str_CopyN(d, s, 100);</code>	

2.17. Touch Screen Functions

Summary of Functions in this section:

- touch_DetectRegion(x1, y1, x2, y2)
- touch_Set(mode)
- touch_Get(mode)

Note: Touch Screen functions do not apply to uVGA-II(GFX) module.

2.17.1. touch_DetectRegion(x1, y1, x2, y2)

Syntax	<code>touch_DetectRegion(x1, y1, x2, y2);</code>	
Arguments	x1, y1, x2, y2	
	x1	specifies the horizontal position of the top left corner of the region.
	y1	specifies the vertical position of the top left corner of the region.
	x2	specifies the horizontal position of the bottom right corner of the region.
	y2	specifies the vertical position of the bottom right corner of the region.
Returns	None	
Description	Specifies a new touch detect region on the screen. This setting will filter out any touch activity outside the region and only touch activity within that region will be reported by the status poll <code>touch_Get(0);</code> function.	

2.17.2. touch_Set(mode)

Syntax	<code>touch_Set(mode);</code>	
Arguments	mode	
	mode	<p>mode = 0 : Enable Touch Screen</p> <p><code>touch_Set(0);</code> Enables and initialises Touch Screen hardware</p> <p>mode = 1 : Disable Touch Screen</p> <p><code>touch_Set(1);</code> Disables the Touch Screen. Note: Touch Screen task runs in the background and disabling it when not in use will free up extra resources for 4DGL CPU cycles.</p> <p>mode = 2 : Default Touch Region</p> <p><code>touch_Set(2);</code> This will reset the current active region to default which is the full screen area</p>
Returns	None	
Description	Sets various Sets various Touch Screen related parameters.	
Example	<code>touch_Set(TOUCH_ENABLE); // .</code>	

2.17.3. touch_Get(mode)

Syntax	touch_Get(mode);	
Arguments	mode	
	mode	mode = 0 : Get Status mode = 1 : Get X coordinates mode = 2 : Get Y coordinates
Returns	Value	
	Value	mode = 0 Returns the various states of the touch screen 0 = INVALID/NOTOUCH 1 = PRESS 2 = RELEASE 3 = MOVING mode = 1 : Returns the X coordinates of the touch mode = 2 : Returns the Y coordinates of the touch
Description	Returns various Touch Screen parameters to caller.	
Example	<pre> state := touch_Get(TOUCH_STATUS); // get touchscreen status x := touch_Get(TOUCH_GETX); y := touch_Get(TOUCH_GETY); if (state == TOUCH_PRESSED) // see if Exit hit if (x > 170 && y > 280) // EXIT button gfx_Cls(); exit := -1; endif if (vertical) if (x > 170 && (y > 240 && y < 270))// Horiz button vertical := 0; exit := 1; endif else if (x > 170 && (y > 200 && y < 230))// Vert button vertical := 1; exit := 2; endif endif endif </pre>	

2.18. Image Control Functions

Summary of Functions in this section:

- `img_SetPosition(handle, index, xpos, ypos)`
- `img_Enable(handle, index)`
- `img_Disable(handle, index)`
- `img_Darken(handle, index)`
- `img_Lighten(handle, index)`
- `img_SetWord(handle, index, offset, word)`
- `img_GetWord(handle, index, offset)`
- `img_Show(handle, index)`
- `img_SetAttributes(handle, index, value)`
- `img_ClearAttributes(handle, index, value)`
- `img_Touched(handle, index)`

2.18.1. `img_SetPosition(handle, index, xpos, ypos)`

Syntax	<code>img_SetPosition(handle, index, xpos, ypos);</code>	
Arguments	handle, index, xpos, ypos	
	handle	Pointer to the Image List.
	index	Index of the images in the list.
	xpos	Top left horizontal screen position where image is to be displayed.
	ypos	Top left vertical screen position where image is to be displayed.
Returns	Status	
	Status	True or False
Description	<p>This function requires that an image control has been created with the <code>file_LoadImageControl(...);</code> function.</p> <p>Sets the position where the image will next be displayed. Returns TRUE if index was ok and function was successful. (the return value is usually ignored).</p> <p>You may turn off an image so when <code>img_Show()</code> is called, the image will not be shown.</p> <p>This function requires that an image control has been created with the <code>file_LoadImageControl(...);</code> function.</p>	
Example	<pre>// make a simple 'window' gfx_Panel(PANEL_RAISED, 0, 0, 239, 239, GRAY); img_SetPosition(Ihndl, BTN_EXIT, 224,2); //set checkout box position img_Enable(Ihndl, BTN_EXIT); //enable checkout box</pre>	

2.18.2. `img_Enable(handle, index)`

Syntax	<code>img_Enable(handle, index);</code>	
Arguments	handle, index	
	handle	Pointer to the Image List.
	index	Index of the images in the list.
Returns	Status	
	Status	TRUE or FALSE.
Description	<p>This function requires that an image control has been created with the <code>file_LoadImageControl(...);</code> function.</p> <p>Enables a selected image in the image list. Returns TRUE if index was ok and function was successful. This is the default state so when <code>img_Show()</code> is called all the images in the list will be shown. To enable all of the images in the list at the same time set index to -1. To enable a selected image, use the image index number.</p>	
Example	<code>r := img_Enable(hImageList, imagenum); //</code>	

2.18.3. `img_Disable(handle, index)`

Syntax	<code>img_Disable(handle, index);</code>	
Arguments	handle, index	
	handle	Pointer to the Image List.
	index	Index of the images in the list.
Returns	Status	
	Status	TRUE or FALSE
Description	<p>This function requires that an image control has been created with the <code>file_LoadImageControl(...);</code> function.</p> <p>Disables an image in the image list. Returns TRUE if index was ok and function was successful. Use this function to turn off an image so that when <code>img_Show()</code> is called the selected image in the list will not be shown. To disable all of the images in the list at the same time set index to -1.</p>	
Example	<code>r := img_Disable(hImageList, imagenum);//</code>	

2.18.4. `img_Darken(handle, index)`

Syntax	<code>img_Darken(handle, index);</code>	
Arguments	handle, index	
	handle	Pointer to the Image List.
	index	Index of the images in the list.
Returns	Status	
	Status	TRUE or FALSE
Description	<p>This function requires that an image control has been created with the <code>file_LoadImageControl(...);</code> function.</p> <p>Darken an image in the image list. Returns TRUE if index was ok and function was successful. Use this function to darken an image so that when <code>img_Show()</code> is called the control will take effect. To darken all of the images in the list at the same time set index to -1.</p> <p>Note: This feature will take effect one time only and when <code>img_Show()</code> is called again the darkened image will revert back to normal.</p>	
Example	<code>r := img_Darken(hImageList, imagenum);</code>	

2.18.5. `img_Lighten(handle, index)`

Syntax	<code>img_Lighten(handle, index);</code>	
Arguments	handle, index	
	handle	Pointer to the Image List.
	index	Index of the images in the list.
Returns	Status	
	Status	TRUE or FALSE
Description	<p>This function requires that an image control has been created with the <code>file_LoadImageControl(...);</code> function.</p> <p>Lighten an image in the image list. Returns TRUE if index was ok and function was successful. Use this function to lighten an image so that when <code>img_Show()</code> is called the control will take effect. To lighten all of the images in the list at the same time set index to -1.</p> <p>Note: This feature will take effect one time only and when <code>img_Show()</code> is called again the lightened image will revert back to normal.</p>	
Example	<code>r := img_Lighten(hImageList, imagenum);</code>	

2.18.6. `img_SetWord(handle, index, offset, word)`

Syntax	<code>img_SetWord(handle, index, offset, word);</code>	
Arguments	handle, index	
	handle	Pointer to the Image List.
	index	Index of the images in the list.
	offset	Offset of the required word in the image entry
	word	The word to be written to the entry
Returns	Status	
	Status	TRUE or FALSE
Description	<p>This function requires that an image control has been created with the <code>file_LoadImageControl(...);</code> function.</p> <p>Set specified word in an image entry. Returns TRUE if successful, return value usually ignored.</p> <pre> IMAGE_XPOS 2 // WORD image location X IMAGE_YPOS 3 // WORD image location Y IMAGE_FLAGS 6 // WORD image flags IMAGE_DELAY 7 // WORD inter frame delay IMAGE_INDEX 9 // WORD current frame IMAGE_TAG 12 // WORD user variable #1 IMAGE_TAG2 13 // WORD user variable #2 </pre> <p>Note: Not all Constants are listed as some are Read Only.</p> <p><code>img_Show(..)</code> will now show error box for out of range video frames. Also, if frame is set to -1, just a rectangle will be drawn in background colour to blank an image. It applies to PmmC R29 or above.</p>	
Example	<pre> func cat() var private frame := 0; // start with frame 0 var private image := SPRITE_CAT; // cat image, can be changed with // cat.image := xxx var private speed := 30; img_SetWord(Ihndl, image, IMAGE_INDEX, frame++); frame := frame % img_GetWord(Ihndl, image, IMAGE_FRAMES); img_Show(Ihndl, image); sys_SetTimer(TIMER3, speed); // reset the event timer endfunc </pre>	

2.18.7. `img_GetWord(handle, index, offset)`

Syntax	<code>img_GetWord(handle, index, offset);</code>																																											
Arguments	handle, index																																											
	handle	Pointer to the Image List.																																										
	index	Index of the images in the list.																																										
	offset	Offset of the required word in the image entry																																										
Returns	Value																																											
	value	Returns the image entry in the list.																																										
Description	<p>This function requires that an image control has been created with the <code>file_LoadImageControl(...);</code> function.</p> <p>Returns specified word from an image entry.</p> <table border="0"> <tr><td>IMAGE_LOWORD</td><td>0</td><td>// WORD image address LO</td></tr> <tr><td>IMAGE_HIWORD</td><td>1</td><td>// WORD image address HI</td></tr> <tr><td>IMAGE_XPOS</td><td>2</td><td>// WORD image location X</td></tr> <tr><td>IMAGE_YPOS</td><td>3</td><td>// WORD image location Y</td></tr> <tr><td>IMAGE_WIDTH</td><td>4</td><td>// WORD image width</td></tr> <tr><td>IMAGE_HEIGHT</td><td>5</td><td>// WORD image height</td></tr> <tr><td>IMAGE_FLAGS</td><td>6</td><td>// WORD image flags</td></tr> <tr><td>IMAGE_DELAY</td><td>7</td><td>// WORD inter frame delay</td></tr> <tr><td>IMAGE_FRAMES</td><td>8</td><td>// WORD number of frames</td></tr> <tr><td>IMAGE_INDEX</td><td>9</td><td>// WORD current frame</td></tr> <tr><td>IMAGE_CLUSTER</td><td>10</td><td>// WORD image start cluster pos (for FAT16 only)</td></tr> <tr><td>IMAGE_SECTOR</td><td>11</td><td>// WORD image start sector in cluster pos (for FAT16 only)</td></tr> <tr><td>IMAGE_TAG</td><td>12</td><td>// WORD user variable #1</td></tr> <tr><td>IMAGE_TAG2</td><td>13</td><td>// WORD user variable #2</td></tr> </table>		IMAGE_LOWORD	0	// WORD image address LO	IMAGE_HIWORD	1	// WORD image address HI	IMAGE_XPOS	2	// WORD image location X	IMAGE_YPOS	3	// WORD image location Y	IMAGE_WIDTH	4	// WORD image width	IMAGE_HEIGHT	5	// WORD image height	IMAGE_FLAGS	6	// WORD image flags	IMAGE_DELAY	7	// WORD inter frame delay	IMAGE_FRAMES	8	// WORD number of frames	IMAGE_INDEX	9	// WORD current frame	IMAGE_CLUSTER	10	// WORD image start cluster pos (for FAT16 only)	IMAGE_SECTOR	11	// WORD image start sector in cluster pos (for FAT16 only)	IMAGE_TAG	12	// WORD user variable #1	IMAGE_TAG2	13	// WORD user variable #2
IMAGE_LOWORD	0	// WORD image address LO																																										
IMAGE_HIWORD	1	// WORD image address HI																																										
IMAGE_XPOS	2	// WORD image location X																																										
IMAGE_YPOS	3	// WORD image location Y																																										
IMAGE_WIDTH	4	// WORD image width																																										
IMAGE_HEIGHT	5	// WORD image height																																										
IMAGE_FLAGS	6	// WORD image flags																																										
IMAGE_DELAY	7	// WORD inter frame delay																																										
IMAGE_FRAMES	8	// WORD number of frames																																										
IMAGE_INDEX	9	// WORD current frame																																										
IMAGE_CLUSTER	10	// WORD image start cluster pos (for FAT16 only)																																										
IMAGE_SECTOR	11	// WORD image start sector in cluster pos (for FAT16 only)																																										
IMAGE_TAG	12	// WORD user variable #1																																										
IMAGE_TAG2	13	// WORD user variable #2																																										
Example	<code>myvar := img_GetWord(hndl, 5, IMAGE_YPOS); //</code>																																											

2.18.8. `img_Show(handle, index)`

Syntax	<code>img_Show(handle, index);</code>	
Arguments	handle, index	
	handle	Pointer to the Image List.
	index	Index of the images in the list.
Returns	Status	
	Status	TRUE or FALSE.
Description	<p>This function requires that an image control has been created with the <code>file_LoadImageControl(...);</code> function.</p> <p>Enable the displaying of the image entry in the image control. Returns TRUE if successful but return value is usually ignored.</p>	
Example	<code>img_Show(hImageList, imagenum);</code>	

2.18.9. `img_SetAttributes(handle, index, value)`

Syntax	<code>img_SetAttributes(handle, index, value);</code>	
Arguments	handle, index, value	
	handle	Pointer to the Image List.
	index	Index of the images in the list.
	value	Refers to various bits in the image control entry (see image attribute flags)
Returns	Status	
	Status	TRUE or FALSE
Description	<p>This function SETS one or more bits in the IMAGE_FLAGS field of an image control entry. "value" refers to various bits in the image control entry (see image attribute flags). A '1' bit in the "value" field SETS the respective bit in the IMAGE_FLAGS field of the image control entry.</p> <p>I_ENABLED 0x8000 // bit 15, set for image enabled I_DARKEN 0x4000 // bit 14, display dimmed I_LIGHTEN 0x2000 // bit 13, display bright I_TOUCHED 0x1000 // bit 12, touch test result I_Y_LOCK 0x0800 // bit 11, stop Y movement I_X_LOCK 0x0400 // bit 10, stop X movement I_TOPMOST 0x0200 // bit 9, draw on top of other images next update I_STAYONTOP 0x0100 // bit 8, draw on top of other images always</p> <p><code>img_ClearAttributes(handle, index, value);</code></p>	
Example	<pre> : : img_Enable(Ihndl, SPRITE_CAT); // we'll also use small cat video img_SetAttributes(Ihndl, SPRITE_CAT, I_NOGROUP); img_SetPosition(Ihndl, SPRITE_CAT, 160, 180); // set its position : </pre>	

2.18.10. `img_ClearAttributes(handle, index, value)`

Syntax	<code>img_ClearAttributes(handle, index, value);</code>																	
Arguments	handle, index, value																	
	handle	Pointer to the Image List.																
	index	Index of the images in the list.																
	value	a '1' bit indicates that a bit should be set and a '0' bit indicates that a bit is not altered. Note: if index is set to -1, the attribute is altered in ALL of the entries in the image list . The constant ALL is set to -1 specifically for this purpose.																
Returns	Status																	
	Status	TRUE or FALSE																
Description	<p>Clear various image attribute flags in a image control entry. (see image attribute flags below)</p> <p>Image attribute flags may be combined with the + or operators, eg:- <code>img_ClearAttributes(hndl, ALL, I_Y_LOCK I_X_LOCK); // allow all images to move in any direction</code></p> <p>This function requires that an image control has been created with the <code>file_LoadImageControl(...);</code> function. Returns TRUE if index was ok and function was successful. (the return value is usually ignored).</p> <p>Image attribute flags</p> <table> <tr> <td><code>I_ENABLED</code></td> <td><code>0x8000</code> // bit 15, set for image enabled</td> </tr> <tr> <td><code>I_DARKEN</code></td> <td><code>0x4000</code> // bit 14, display dimmed</td> </tr> <tr> <td><code>I_LIGHTEN</code></td> <td><code>0x2000</code> // bit 13, display bright</td> </tr> <tr> <td><code>I_TOUCHED</code></td> <td><code>0x1000</code> // bit 12, touch test result</td> </tr> <tr> <td><code>I_Y_LOCK</code></td> <td><code>0x0800</code> // bit 11, stop Y movement</td> </tr> <tr> <td><code>I_X_LOCK</code></td> <td><code>0x0400</code> // bit 10, stop X movement</td> </tr> <tr> <td><code>I_TOPMOST</code></td> <td><code>0x0200</code> // bit 9, draw on top of other images next update</td> </tr> <tr> <td><code>I_STAYONTOP</code></td> <td><code>0x0100</code> // bit 8, draw on top of other images always</td> </tr> </table>		<code>I_ENABLED</code>	<code>0x8000</code> // bit 15, set for image enabled	<code>I_DARKEN</code>	<code>0x4000</code> // bit 14, display dimmed	<code>I_LIGHTEN</code>	<code>0x2000</code> // bit 13, display bright	<code>I_TOUCHED</code>	<code>0x1000</code> // bit 12, touch test result	<code>I_Y_LOCK</code>	<code>0x0800</code> // bit 11, stop Y movement	<code>I_X_LOCK</code>	<code>0x0400</code> // bit 10, stop X movement	<code>I_TOPMOST</code>	<code>0x0200</code> // bit 9, draw on top of other images next update	<code>I_STAYONTOP</code>	<code>0x0100</code> // bit 8, draw on top of other images always
<code>I_ENABLED</code>	<code>0x8000</code> // bit 15, set for image enabled																	
<code>I_DARKEN</code>	<code>0x4000</code> // bit 14, display dimmed																	
<code>I_LIGHTEN</code>	<code>0x2000</code> // bit 13, display bright																	
<code>I_TOUCHED</code>	<code>0x1000</code> // bit 12, touch test result																	
<code>I_Y_LOCK</code>	<code>0x0800</code> // bit 11, stop Y movement																	
<code>I_X_LOCK</code>	<code>0x0400</code> // bit 10, stop X movement																	
<code>I_TOPMOST</code>	<code>0x0200</code> // bit 9, draw on top of other images next update																	
<code>I_STAYONTOP</code>	<code>0x0100</code> // bit 8, draw on top of other images always																	
Example	<code>img_ClearAttributes(hndl, 5, value); //</code>																	

2.18.11. `img_Touched(handle, index)`

Syntax	<code>img_Touched(handle, index);</code>	
Arguments	handle, index	
	handle	Pointer to the Image List.
	index	Index of the images in the list.
Returns	Status	
	Status	Returns index or -1.
Description	<p>This function requires that an image control has been created with the <code>file_LoadImageControl(...);</code> function.</p> <p>Returns index if image touched or returns -1 image not touched. If index is passed as -1 the function tests all images and returns -1 if image not touched or returns index.</p>	
Example	<pre> if(state == TOUCH_PRESSED) n := img_Touched(Ihndl, -1); //scan image list, looking for a touch if(n != -1) last := n; button := n; img_Lighten(Ihndl, n); //lighten the button touched img_Show(Ihndl, -1); // restore the images endif endif </pre>	

2.19. Memory Allocation Functions

Summary of Functions in this section:

- mem_Alloc(size)
- mem_Allocv(size)
- mem_Allocz(size)
- mem_Realloc(ptr, size)
- mem_Free(allocation)
- mem_Heap()
- mem_Set(ptr, char, size)
- mem_Copy(source, destination, count)
- mem_Compare(ptr1, ptr2, count)

2.19.1. mem_Alloc(size)

Syntax	<code>mem_Alloc(size);</code>	
Arguments	size (byte)	
	size	Specifies the number of bytes that's allocated from the heap.
Returns	value	
	value	Returned value is the pointer (Word) to the allocation if successful. If function fails returns a null (0).
Description	Allocate a block of memory to pointer myvar. The allocated memory contains garbage but is a fast allocation. The block must later be released with <code>mem_Free(myvar);</code>	
Example	<code>myvar := mem_Alloc(100); //</code>	

2.19.2. mem_AllocV(size)

Syntax	<code>mem_AllocV(size);</code>	
Arguments	size (Byte)	
	size	Specifies the number of bytes that's allocated from the heap.
Returns	Value	
	Value	Returned value is the pointer (Word) to the allocation if successful. If function fails returns a null (0).
Description	Allocate a block of memory to pointer myvar. The block of memory is filled with initial signature values. The block starts with A5,5A then fills with incrementing number eg:- A5,5A,00,01,02,03...FF,00,11.... This can be helpful when debugging. The block must later be released with mem_Free(myvar).	
Example	<code>myvar := mem_AllocV(100); //</code>	

2.19.3. mem_Allocz(size)

Syntax	<code>mem_Allocz(size);</code>	
Arguments	size	
	size	Specifies the number of bytes that's allocated from the heap.
Returns	Value	
	Value	Returned value is the pointer to the allocation if successful. If function fails returns a null (0).
Description	Allocate a block of memory to pointer myvar. The block of memory is filled with zeros. The block must later be released with <code>mem_Free(myvar);</code>	
Example	<code>myvar := mem_Allocz(100); //</code>	

2.19.4. mem_Realloc(&ptr, size)

Syntax	<code>mem_Realloc(&ptr, size);</code>	
Arguments	<code>ptr, size</code>	
	<code>ptr</code>	specifies the new location to reallocate the memory block.
	<code>size</code>	specifies the number of bytes of the block.
Returns	Status	
	Status	See the Description.
Description	The function may move the memory block to a new location, in which case the new location is returned. The content of the memory block is preserved up to the lesser of the new and old sizes, even if the block is moved. If the new size is larger, the value of the newly allocated portion is indeterminate. In case that <code>ptr</code> is NULL, the function behaves exactly as <code>mem_Alloc()</code> , assigning a new block of <code>size</code> bytes and returning a pointer to the beginning of it. In case that the <code>size</code> is 0, the memory previously allocated in <code>ptr</code> is deallocated as if a call to <code>mem_Free(myvar)</code> was made, and a NULL pointer is returned.	
Example	<code>myvar := mem_Realloc(myptr, 100); //</code>	

2.19.5. mem_Free(allocation)

Syntax	mem_Free(allocation);	
Arguments	allocation	
	allocation	specifies the location of memory block to free up.
Returns	Status	
	Status	Returns non-zero if function is successful Returns 0 if the function fails.
Description	The function de-allocates a block of memory previously created with mem_Alloc(...), mem_AllocV(...) or mem_AllocZ(...).	
Example	<code>test := mem_Free(myvar); //</code>	

2.19.6. mem_Heap()

Syntax	<code>mem_Heap();</code>	
Arguments	None	
Returns	Value	
	Value	Returns the largest available memory chunk of the heap.
Description	Returns byte size of the largest chunk of memory available in the heap.	
Example	<code>howmuch := mem_Heap();</code>	

2.19.7. mem_Set(ptr, char, size)

Syntax	mem_Set(ptr, char, size);	
Arguments	ptr, char, size	
	ptr	specifies the memory block.
	char	specifies the value to fill the block with.
	size	specifies the size of the block in Bytes.
Returns	Pointer	
	Pointer	Returns the pointer.
Description	Fill a block of memory with a byte value.	
Example	<pre> var mybuf[5]; var i; func main() mem_Set(mybuf,0x55,5); //Only fills half of mybuf[] for(i:=0;i<sizeof(mybuf);i++) //Show what is in the buffer print(" 0x",[HEX]mybuf[i]); next mem_Set(mybuf,0xAA,sizeof(mybuf)*2); //Fill entire buffer print("\n"); //New line for(i:=0;i<sizeof(mybuf);i++) print(" 0x",[HEX]mybuf[i]); next repeat forever </pre>	

2.19.8. mem_Copy(source, destination, count)

Syntax	mem_Copy(source, destination, count);	
Arguments	source, destination, count	
	source	specifies the source memory block.
	destination	specifies the destination memory block.
	count	specifies the size of the blocks.
Returns	Pointer	
	Pointer	Returns source.
Description	Copy a block of memory from source to destination. Note: src can be a string constant eg:- myptr := mem_Copy("TEST STRING", ptr2, 12);	
Example	<pre>myptr := mem_Copy(ptr1, ptr2, 100); //</pre>	

2.19.9. mem_Compare(ptr1, ptr2, count)

Syntax	<code>mem_Compare(ptr1, ptr2, count);</code>	
Arguments	ptr1, ptr2, count	
	ptr1	specifies the 1st memory block.
	ptr2	specifies the 2nd memory block.
	count	specifies the number of bytes to compare.
Returns	Value	
	Value	Returns 0 if we have a match, -1 if ptr1 < ptr2, and +1 if ptr2 > ptr1. (The comparison is done alphabetically)
Description	Compare two blocks of memory ptr1 and ptr2 .	
Example	<code>test := mem_Compare(this_block, that_block, 100); //</code>	

2.20. General Purpose Functions

Summary of Functions in this section:

- pause(time)
- lookup8 (**key**, byteConstList)
- lookup16 (**key**, wordConstList)

2.20.1. pause(time)

Syntax	pause(time);	
Arguments	time	
	time	A value specifying the delay time in milliseconds.
	The arguments can be a variable, array element, expression or constant	
Returns	nothing	
Description	Stop execution of the user program for a predetermined amount of time.	
Example	<pre> if (status) // if fire button pressed pause(30) // slow down the loop else ... </pre>	

2.20.2. lookup8(key, byteConstList)

Syntax	lookup8(key, byteConstList);	
Arguments	key, byteConstList	
	key	A byte value to search for in a fixed list of constants. The key argument can be a variable, array element, expression or constant
	byteConstList	A comma separated list of constants and strings to be matched against key . Note: the string of constants may be freely formed, see example.
Returns	result	
	result	See description.
Description	<p>Search a list of 8 bit constant values for a match with a search value key. If found, the index of the matching constant is returned in result, else result is set to zero. Thus, if the value is found first in the list, result is set to one. If second in the list, result is set to two etc. If not found, result is returned with zero.</p> <p>Note: The list of constants cannot be re-directed. The <code>lookup8(...)</code> functions offer a versatile way for returning an index for a given value. This can be very useful for data entry filtering and parameter input checking and where ever you need to check the validity of certain inputs. The entire search list field can be replaced with a single name if you use the \$ operator in constant, eg:</p> <pre>#constant HEXVALUES \$"0123456789ABCDEF"</pre>	
Example	<pre>func main() var key, r; key := 'a'; r := lookup8(key, 0x4D, "abcd", 2, 'Z', 5); print("\nSearch value 'a' \nfound as index ", r) key := 5; r := lookup8(key, 0x4D, "abcd", 2, 'Z', 5); print("\nSearch value 5 \nfound at index ", r) putstr("\nScanning..\n"); key := -12000; // we will count from -12000 to +12000, only // the hex ascii values will give a match value while(key <= 12000) r := lookup8(key, "0123456789ABCDEF"); // hex lookup if(r) print([HEX1] r-1); // only print if we got a match in // the table key++; wend repeat forever endfunc</pre>	

2.20.3. lookup16(key, wordConstList)

Syntax	<code>lookup16(key, wordConstList);</code>	
Arguments	key, wordConstList	
	key	A word value to search for in a fixed list of constants. The key argument can be a variable, array element, expression or constant
	wordConstList	A comma separated list of constants to be matched against key .
Returns	result	
	result	See description.
Description	<p>Search a list of 16 bit constant values for a match with a search value key. If found, the index of the matching constant is returned in result, else result is set to zero. Thus, if the value is found first in the list, result is set to one. If second in the list, result is set to two etc. If not found, result is returned with zero.</p> <p>Note: The <code>lookup16(...)</code> functions offer a versatile way for returning an index for a given value. This is very useful for parameter input checking and where ever you need to check the validity of certain values. The entire search list field can be replaced with a single name by using the \$ operator in constant, eg:</p> <pre>#constant LEGALVALS \$5,10,20,50,100,200,500,1000,2000,5000,10000</pre>	
Example	<pre>func main() var key, r; key := 5000; r := lookup16(key, 5,10,20,50,100,200,500,1000,2000,5000,10000); //r := lookup16(key, LEGALVALS); if(r) print("\nSearch value 5000 \nfound at index ", r); else putstr("\nValue not found"); endif print("\nOk"); // all done repeat forever endfunc</pre>	

3. PICASO EVE System Registers Memory Map

The following tables outline in detail the PICASO-GFX2 system registers and flags.

Table 3.1: WORD-Size Registers Memory Map			
LABEL	ADDRESS		USAGE
	DEC	HEX	
RANDOM_LO	32	0x20	random generator LO word
RANDOM_HI	33	0x21	random generator HI word
SYSTEM_TIMER_LO	34	0x22	1msec system timer LO word
SYSTEM_TIMER_HI	35	0x23	1msec system timer HI word
TIMER0	36	0x24	1msec user timer 0
TIMER1	37	0x25	1msec user timer 1
TIMER2	38	0x26	1msec user timer 2
TIMER3	39	0x27	1msec user timer 3
TIMER4	40	0x28	1msec user timer 3
TIMER5	41	0x29	1msec user timer 3
TIMER6	42	0x2A	1msec user timer 3
TIMER7	43	0x2B	1msec user timer 3
SYS_X_MAX	44	0x2C	display hardware X res-1
SYS_Y_MAX	45	0x2D	display hardware Y res-1
GFX_XMAX	46	0x2E	width of current orientation
GFX_YMAX	47	0x2F	height of current orientation
GFX_LEFT	48	0x30	image left real point
GFX_TOP	49	0x31	image top real point
GFX_RIGHT	50	0x32	image right real point
GFX_BOTTOM	51	0x33	image bottom real point
GFX_X1	52	0x34	image left clipped point
GFX_Y1	53	0x35	image top clipped point
GFX_X2	54	0x36	image right clipped point
GFX_Y2	55	0x37	image bottom clipped point
GFX_X_ORG	56	0x38	current X origin
GFX_Y_ORG	57	0x39	current Y origin
GFX_HILITE_LINE	58	0x3A	current multi line button hilite line
GFX_LINE_COUNT	59	0x3B	count of lines in multiline button
GFX_LAST_SELECTION	60	0x3C	Last selected line
GFX_HIGHLIGHT_BACKGROUND	61	0x3D	multi button hilite background colour
GFX_HIGHLIGHT_FOREGROUND	62	0x3E	multi button hilite background colour
GFX_BUTTON_FOREGROUND	63	0x3F	store default text colour for hilite line tracker

GFX_BUTTON_BACKGROUND	64	0x40	store default button colour for hilite line tracker
GFX_BUTTON_MODE	65	0x41	store current buttons mode
GFX_TOOLBAR_HEIGHT	66	0x42	height above
GFX_STATUSBAR_HEIGHT	67	0x43	height below
GFX_LEFT_GUTTER_WIDTH	68	0x44	width to left
GFX_RIGHT_GUTTER_WIDTH	69	0x45	width to right
GFX_PIXEL_SHIFT	70	0x46	pixel shift for button depress illusion
GFX_VECT_X1	71	0x47	gp rect, used by multiline button to hilite required line
GFX_VECT_Y1	72	0x48	
GFX_VECT_X2	73	0x49	
GFX_VECT_Y2	74	0x4A	
GFX_THUMB_PERCENT	75	0x4B	size of slider thumb as percentage
GFX_THUMB_BORDER_DARK	76	0x4C	darker shadow of thumb
GFX_THUMB_BORDER_LIGHT	77	0x4D	lighter shadow of thumb
TOUCH_XMINCAL	78	0x4E	touch calibration value
TOUCH_YMINCAL	79	0x4F	touch calibration value
TOUCH_XMAXCAL	80	0x50	touch calibration value
TOUCH_YMAXCAL	81	0x51	touch calibration value
IMG_WIDTH	82	0x52	width of currently loaded image
IMG_HEIGHT	83	0x53	height of currently loaded image
IMG_FRAME_DELAY	84	0x54	if image, else inter frame delay for movie
IMG_FLAGS	85	0x55	bit 4 determines colour mode, other bits reserved
IMG_FRAME_COUNT	86	0x56	count of frames in a movie
IMG_PIXEL_COUNT_LO	87	0x57	count of pixels in the current frame
IMG_PIXEL_COUNT_HI	88	0x58	count of pixels in the current frame
IMG_CURRENT_FRAME	89	0x59	last frame shown
MEDIA_ADDRESS_LO	90	0x5A	uSD byte address LO
MEDIA_ADDRESS_HI	91	0x5B	uSD byte address HI
MEDIA_SECTOR_LO	92	0x5C	uSD sector address LO
MEDIA_SECTOR_HI	93	0x5D	uSD sector address HI
MEDIA_SECTOR_COUNT	94	0x5E	uSD number of bytes remaining in sector
TEXT_XPOS	95	0x5F	text current x pixel position
TEXT_YPOS	96	0x60	text current y pixel position
TEXT_MARGIN	97	0x61	text left pixel pos for carriage return
TXT_FONT_TYPE	98	0x62	font type, 0 = system font, else pointer to user font
TXT_FONT_MAX	99	0x63	max number of chars in font
TXT_FONT_OFFSET	100	0x64	starting offset (normally 0x20)
TXT_FONT_WIDTH	101	0x65	current font width
TXT_FONT_HEIGHT	102	0x66	Current font height

GFX_TOUCH_REGION_X1	103	0x67	touch capture region
GFX_TOUCH_REGION_Y	104	0x68	
GFX_TOUCH_REGION_X2	105	0x69	
GFX_TOUCH_REGION_Y2	106	0x6A	
GFX_CLIP_LEFT_VAL	107	0x6B	left clipping point (set with gfx_ClipWindow(...))
GFX_CLIP_TOP_VAL	108	0x6C	top clipping point (set with gfx_ClipWindow(...))
GFX_CLIP_RIGHT_VAL	109	0x6D	right clipping point (set with gfx_ClipWindow(...))
GFX_CLIP_BOTTOM_VAL	110	0x6E	bottom clipping point (set with gfx_ClipWindow(...))
GFX_CLIP_LEFT	111	0x6F	current clip value (reads full size if clipping turned off)
GFX_CLIP_TOP	112	0x70	current clip value (reads full size if clipping turned off)
GFX_CLIP_RIGHT	113	0x71	current clip value (reads full size if clipping turned off)
GFX_CLIP_BOTTOM	114	0x72	current clip value (reads full size if clipping turned off)
GRAM_PIXEL_COUNT_LO	115	0x73	LO word of count of pixels in the set GRAM area
GRAM_PIXEL_COUNT_HI	116	0x74	HI word of count of pixels in the set GRAM area
TOUCH_RAW_X	117	0x75	12 bit raw A2D X value from touch screen
TOUCH_RAW_Y	118	0x76	12 bit raw A2D Y value from touch screen
GFX_LAST_CHAR_WIDTH	119	0x77	calculated char width from last call to charWidth function
GFX_LAST_CHAR_HEIGHT	120	0x78	calculated height from last call to charHeight function
GFX_LAST_STR_WIDTH	121	0x79	calculated width from last call to strWidth function
GFX_LAST_STR_HEIGHT	122	0x7A	calculated height from last call to strHeight function

NOTE: These registers are accessible with [peekW](#) and [pokeW](#) functions.

4. Appendix A : Example 4DGL Code

```
#platform "uOLED-32028-P1_GFX2"

/*****
* Filename: Window.4dg
* Created: 2010/06/17
* Author: 4D
* Description: A simple window object example
*
*
* NB:- This program should be written to flash so
* it becomes the top down program.
*
*****/

#inherit "4DGL_16bitColours.fnc"
//#inherit "FONT4.fnt"

#MODE RUNFLASH // this prog intended to be 'front end' and run from FLASH

#STACK 500 // make sure stack is big enough for main prog and called
functions

// colour scheme
#CONST
    WINDOW_COLOR        GRAY
    TITLEBAR_COLOR      NAVY
    TITLETXT_COLOR      CYAN
    STATUSBAR_COLOR     GRAY
    STATUSTXT_COLOR     YELLOW
#END

//-----
// local global variables
//-----
var D; // pointer to disk struct
// (we keep 2 copies so we can test for a state -
var tempstr[20]; // general purpose string, 40 bytes

//=====
// button texts
//=====
#DATA
    word buttontexts tst1, tst2, tst3, tst4, btnexit
    byte tst1 "TEST1\0"
    byte tst2 "TEST2\0"
    byte tst3 "TEST3\0"
    byte tst4 "TEST4\0"
    byte btnexit "_\0"
#END

//=====
// In the main function, we establish a simple window and activate it.
// From then on, it is a simple matter of polling the window, and acting
// on the number (message) it returns. This greatly simplifies the
// application, as all touch testing is handled by the window itself.
//=====
func main()
    var Wmsg; // message from window

    gfx_Cls();
    txt_Set(FONT_ID, FONT3);
    print("Memory available = ",mem_Heap(),"\n"); //show biggest chunk we have

    // set some window properties
```

```

aWindow.title := "A Test Window";
aWindow.xpos := 10;
aWindow.ypos := 60;
aWindow.font := FONT2;
aWindow(INITIALIZE);          // draw window / buttons for the first time

pause(500);
aWindow.statusbartext := init_Drive(); //mount the disk, setting status msg

aWindow(REDRAW_STATUS);      // update the status bar

// now just stay in a loop, getting info from window
repeat
    Wmsg := aWindow(SCAN); // scan for any changes

    // if return value non zero, its a button number
    if(Wmsg)

        switch
            //-----
            // would normall do some exit action here
            // but for demo we just reset the window
            //-----
            case (Wmsg == MAXBUTTONS) // if it was the exit (last) button

                aWindow(INITIALIZE);
                break;

            //-----
            // update status and title with the button number
            //-----
            case (Wmsg > 0 && Wmsg < MAXBUTTONS)
                to(tempstr); print("Button #",Wmsg);
                // print return value to the temp buffer
                to(APPEND); putstr(" ");
                // clear string tail
                aWindow.statusbartext := tempstr;
                // use temp buffer for status text
                aWindow(REDRAW_STATUS);
                // update the status bar

                to(tempstr); putstr(buttontexts[Wmsg-1]);
                // print the button text to the temp buffer
                to(APPEND); putstr(" ");
                // clear string tail
                aWindow.title := tempstr;
                // use temp buffer for title text
                aWindow(REDRAW_TITLE);
                // update the title bar
                break;

            default:

        endswitch

    endif
forever
endfunc

#constant MAXBUTTONS 5          // 4 pushbuttons

// enumeration for the window's sub functions
#constant INITIALIZE, UPDATE, SCAN, REDRAW_TITLE, REDRAW_STATUS

// example for a simple Window object
func aWindow(var subfunc)

    // window properties

```

```

var private xpos, ypos; // window position
var private windowHeight := 200; // default window height
var private windowcolor := WINDOW_COLOR; // default window colour

// title bar properties
// title bar text pointer, set default title bar text
var private title; // title bar text pointer
var private font := FONT3; // default font
var private titlebarheight := 20; // default title bar height
var private titlebarcolor := TITLEBAR_COLOR; // default title bar colour
var private titletextcolor := TITLETXT_COLOR; // default title text colour

// status bar properties
var private statusbartext; // status bar text pointer
var private statusbarheight := 10; // default status bar height
var private statusbarcolor := STATUSBAR_COLOR; // default status bar colour
var private statustextcolor := STATUSTXT_COLOR; // default status txt colour

var private btncolor := LIGHTGREY; // default button colour
var private textcolor := BLACK; // default text colour
var private ygap := 4; // vertical gap between buttons
var private touchX1[MAXBUTTONS]; // touch regions for the buttons
var private touchY1[MAXBUTTONS];
var private touchX2[MAXBUTTONS];
var private touchY2[MAXBUTTONS];
var private vButtonState[MAXBUTTONS];
// button state flags (bit 0 = up:down state)
var private vOldButtonState[MAXBUTTONS];
// OLD button state flags (bit 0 = up:down state)

var private lastkey; // last button pressed

// messages
var private touchState; // window touch status
var private touchX; // window x position
var private touchY; // window y position

// local variables
var n, x, y, x1, y1, x2, y2, oldFG, oldBG, oldFont, r, retval;

// save the things we will change
oldFont := peekW(TXT_FONT_ID);
oldFG := peekW(TEXT_COLOUR);
oldBG := peekW(TEXT_BACKGROUND);

// functions methods
gosub(subfunc), (Initialize, Update, Scan, RedrawTitleBar, RedrawStatusBar);

// restore things we changed
txt_FontID(oldFont);
txt_FGcolour(oldFG);
txt_BGcolour(oldBG);

goto exitfunc;

//-----
// reset the window and redraw the buttons to the up state
//-----
Initialize:
touch_Set(TOUCH_ENABLE); // enable the touch screen
gfx_Panel(PANEL_RAISED, xpos, ypos, windowHeight, titlebarheight,
titlebarcolor); // draw title bar panel
gfx_Panel(PANEL_SUNKEN, xpos, peekW(GFX_Y2), windowHeight, windowHeight-
titlebarheight-statusbarheight, windowcolor); // draw main window panel
gfx_Panel(PANEL_RAISED, xpos, peekW(GFX_Y2), windowHeight, statusbarheight,
statusbarcolor); // draw status bar panel

```

```

    x := xpos>windowWidth-titlebarheight;
    y := ypos+2;
    gfx_Button(BUTTON_UP, x, y, OLIVE, ORANGE, FONT1, 1, 1,btnexit );
    // place the quit button

    gosub RedrawTitleBar; // set the title
    gosub RedrawStatusBar; // set the status bar text

    x1 := xpos+10;
    y1 := ypos+30; // set position of the first button offset in the window

    for(n:=0; n<MAXBUTTONS-1; n++) // draw the 4 ush buttons

        // reset the button states
        vButtonState[n]:=UP;
        vOldButtonState[n]:=UP;

        // place a button
        gfx_Button( BUTTON_UP, x1, y1, btncolor, textcolor, font, 1, 1,
buttontexts[n] );

        // get the bottom/right extent
        x2 := gfx_Get(RIGHT_POS);
        y2 := gfx_Get(BOTTOM_POS);

        // register the button position
        touchX1[n] := x1;
        touchY1[n] := y1;
        touchX2[n] := x2;
        touchY2[n] := y2;
        y1 := y2 + ygap; // move down
    next

    touchX1[n] := x; // finally, register exit button position
    touchY1[n] := y;
    touchX2[n] := x+20;
    touchY2[n] := y+20;
    vButtonState[n]:=UP;
    vOldButtonState[n]:=UP;

    title := "NO NAME"; // set default title bar text
    statusbartext := "status..."; // set default status bar text

    gosub RedrawStatusBar;
    gosub RedrawTitleBar;

    //Do any other initializations here

    endsub;

//-----
// Update status bar text
//-----
RedrawStatusBar:
    txt_FontID(FONT1);
    txt_FGcolour(statustextcolor);
    txt_BGcolour(statusbarcolor);
    gfx_MoveTo(xpos+8, ypos>windowHeight-8);
    putstr(statusbartext); // set the status bar text
    endsub;

//-----
// Update status bar text
//-----
RedrawTitleBar:
    txt_FontID(FONT2);
    txt_FGcolour(titletextcolor);
    txt_BGcolour(titlebarcolor);

```

```

    gfx_MoveTo(xpos+8, ypos+5);
    putstr(title); // set the title text
    endsub;

//-----
// Update any buttons that have changed state
//-----
Update:
    for(n:=0; n<MAXBUTTONS; n++)
        if ( vButtonState[n] != vOldButtonState[n])
            vOldButtonState[n] := vButtonState[n];
            gfx_Button( vButtonState[n], touchX1[n], touchY1[n], btncolor,
textcolor, font, 1, 1, buttontexts[n] ); // redraw the button

        endif
    next
    //Do any other update operations here....

endsub;

//-----
// scan for any button presses
//-----
Scan:
touchState := touch_Get(TOUCH_STATUS); // save touchscreen status
touchX := touch_Get(TOUCH_GETX); // and current position
touchY := touch_Get(TOUCH_GETY);

// if screen touched,
if(touchState == TOUCH_PRESSED)

    // scan the hot spots list
    while (n < MAXBUTTONS && !r)
        if (touchX >= touchX1[n] && touchX < touchX2[n] && touchY >= touchY1[n]
&& touchY < touchY2[n]) r := n+1;
        n++;
    wend

    // if any button was pressed
    if(r)
        lastkey := r; // remeber the button
        vButtonState[r-1] := DOWN; // set it to down state
        gosub Update; // update the button action
    endif
endif

if((touchState == TOUCH_RELEASED) && lastkey)
// if touch released and we remember a previous button press,
    retval := lastkey; // set return value with the button number
    vButtonState[lastkey-1] := UP; // last button is now UP
    lastkey := 0; // clear button memory
    gosub Update; // update the button action
endif
endsub;

exitfunc:
    return retval;
endfunc

//=====
// mount the drive, return status message and D will be null if mount fails
//=====
func init_Drive()
    var retry := 10;
    if(!(D := file Mount()))
        while(retry--)
            if((D := file_Mount())) break;
        wend

```

```
        if (retry) return "Mount Failed!";
    endif
    return "Disk mounted";
endfunc
```

```
//=====
```

5. Appendix B : Runtime Error Messages

Error Number	Meaning	Category	
1	Failed to receive 'L' during loading process from Workshop	Workshop	
2	Did not receive valid header info from Workshop	Workshop	
3	Header size does not match loader info	Workshop	
4	Could not allocate enough memory for program	Workshop	
5	Loader checksum error	Workshop	
6	Did not receive header prior to 'L' command	Workshop	
7	Header size entry does not match loader value	Workshop	
8	Failed to load program from FLASH	Internal	
9	Could not allocate code segment	File loader	
10	Could not load function file from disk	File loader	
11	Bad header in program file	File loader	
12	Header in program file differs from file size	File loader	
13	Could not allocate global memory for program file	File loader	
14	Program File checksum error	File loader	
15	EVE Stack Overflow	System	
Error Number	Meaning	V1	V2
16	Unsupported PmmC function	fnc	1 st Arg
17	Illegal COM0 Event Function address	addr	(ignored)
18	Illegal COM1 Event Function address	addr	(ignored)
19	Bad txt_Set(...) command number	command	value
20	Bad gfx_Get(...) command number	command	(ignored)
21	Bad txt_Set(...) command number	command	value
22	Bad address for peekW or pokeW	command	(ignored)
23	Bad timer number for sys_SetTimer(..) or sys_GetTimer(..)	tnum	value
24	Bad timer number for sys_SetTimerFunction(...)	tnum	funcaddr

6. Hardware Tools

The following hardware tools are required for full control of the PICASO Processor.

6.1. 4D Programming Cable

The 4D Programming Cable is an essential hardware tool to program, customise and test the PICASO Processor.

The 4D Programming Cable is used to program a new Firmware/PmmC and downloading compiled 4DGL code into the processor. It even serves as an interface for communicating serial data to the PC.

The 4D Programming Cable is available from 4D Systems, www.4dsystems.com.au



4D Programming Cable

6.2. Evaluation Display Modules

The following modules, available from 4D Systems, can be used for evaluation purposes to discover what the PICASO processor has to offer.

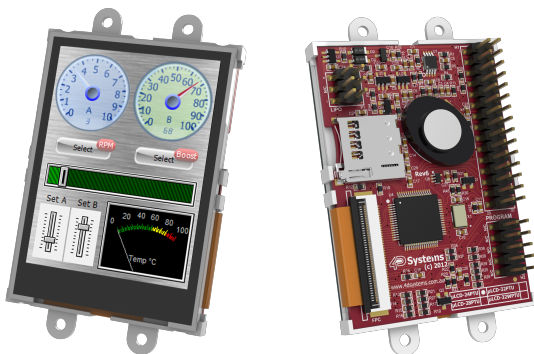

uLCD-24PTU – 2.4" Intelligent PICASO Display

Other modules, such as the 2.8", 3.2" and 3.2" Wide versions are also available. Please contact 4D Systems for more information, or visit the 4D Systems website, www.4dsystems.com.au

7. 4D Systems - Workshop 4 IDE

Workshop 4 is a comprehensive software IDE that provides an integrated software development platform for all of the 4D family of processors and modules. The IDE combines the Editor, Compiler, Linker and Down- Loader to develop complete 4DGL application code. All user application code is developed within the Workshop 4 IDE.

The Workshop 4 IDE supports multiple development environments for the user, to cater for different user requirements and skill level.

- The **Designer** environment enables the user to write 4DGL code in its natural form.
- A visual programming experience, suitably called **ViSi**, enables drag-and-drop type placement of objects to assist with 4DGL code generation and allows the user to visualise how the display will look while being developed.
- An advanced environment called **ViSi-Genie** doesn't require any 4DGL coding at all, it is all done automatically for you. Simply lay the display out with the objects you want, set the events to drive them and the code is written for you automatically. ViSi-Genie provides the latest rapid development experience from 4D Systems.
- A **Serial** environment is also provided to transform the processor into a slave serial processor, allowing the user to control the display from any host microcontroller or device with a serial port.

The Workshop 4 IDE is available from the 4D Systems website. www.4dsystems.com.au

For a comprehensive manual on the Workshop 4 IDE Software, refer to its documentation from the 4D Systems website.

"Workshop-4-IDE-User-Manual.pdf"

7.1. Workshop 4 – Designer Environment

Choose the Designer environment to write 4DGL code in its raw form.

The Designer environment provides the user with a simple yet effective programming environment where pure 4DGL code can be written, compiled and downloaded to the PICASO Processor.

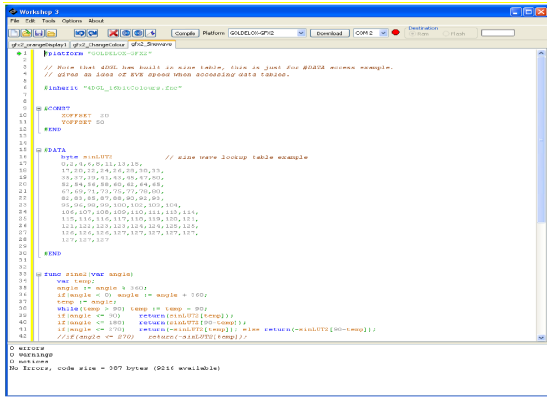

7.2. Workshop 4 – ViSi Environment

ViSi was designed to make the creation of graphical displays a more visual experience.

ViSi is a great software tool that allows the user to see the instant results of their desired graphical layout. Additionally, there is a selection of inbuilt dials, gauges and meters that can simply be placed onto the simulated module display. From here each object can have its properties edited, and at the click of a button all relevant 4DGL code associated with that object is produced in the user program. The user can then write 4DGL code around these objects to utilise them in the way they choose.

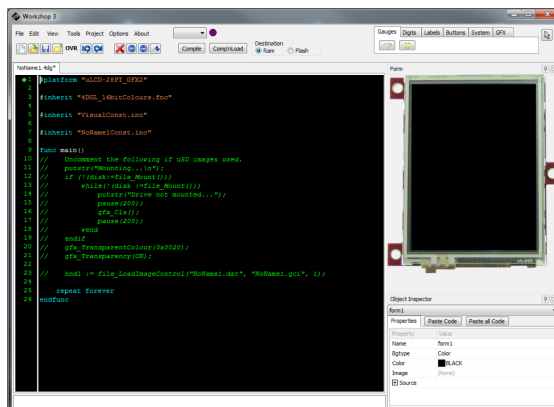

7.3. Workshop 4 – ViSi Genie Environment

ViSi Genie is a breakthrough in the way 4D Systems' graphic display modules and processors are programmed. It is an environment like no other, a code-less programming environment that provides the user with a rapid visual experience, enabling a simple GUI application to be 'written' from scratch in literally seconds.

ViSi Genie does all the background coding, no 4DGL to learn, it does it all for you.

Pick and choose the relevant objects to place on the display, much like the ViSi Environment (See Section 11.2), yet without having to write a single line of code. Each object has parameters which can be set, and configurable events to animate and drive other objects or communicate with external devices.

Simply place an object on the screen, position and size it to suit, set the parameters such as colour, range, text, and finally select the event you wish the object to be associated with, it is that simple.

In seconds you can transform a blank display into a fully animated GUI with moving sliders, animated press and release buttons, and much more. All without writing a single line of code!

ViSi Genie provides the user with a feature rich rapid development environment, second to none.

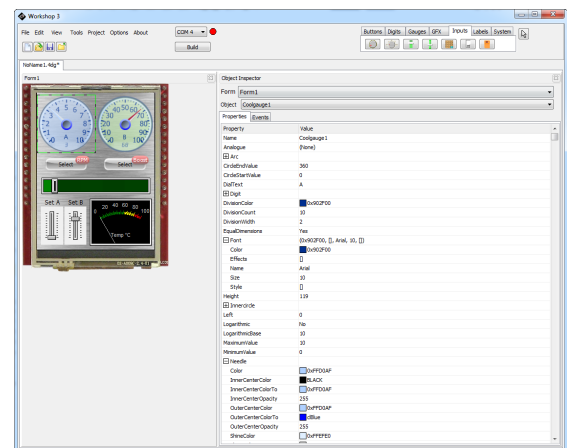

7.4. Workshop 4 – Serial Environment

The Serial environment in the Workshop 4 IDE provides the user the ability to transform the PICASO Processor into a slave serial graphics processor.

This enables the user to use their favourite microcontroller or serial device as the Host, without having to learn 4DGL or program in a separate IDE. Once the PICASO is configured and downloaded to from the Serial Environment, simple graphic commands can be sent from the users host microcontroller to display primitives, images, sound or even video.

8. Revision History

Revision History		
Revision	Revision Content	Revision Date
1.0	First Release	20/06/2010
2.0	<p>1-Incorrect heading and discrepancy in the description of bus_Write Function; fixed.</p> <p>2-Fixed typing error in the bus_Read Function.</p> <p>3-Erroneous references in sec 2.4.12 to “note #5”, “note #6”, “note #7” and “note #8” removed. Proper descriptions added.</p> <p>4-Replaced FONT_SIZE with FONT_ID at several places.</p> <p>5-X_RES is replaced with X_MAX. Y_RES is replaced with Y_MAX in sec 2.6.39</p> <p>6-str_Append is replaced with str_Cat in the example in sec 2.16.16.</p> <p>7-str_Append is replaced with str_CatN in the example in sec 2.16.17.</p>	25/10/2010
3.0	<p>1-Fixed typing error in Sec 2.19.1, Sec 2.19.2 and Sec 2.19.3.</p> <p>2-Added Details for Transparency functions. Sec 2.6.41.</p> <p>3-Added Details for uVGA-II(GFX) related functions in Sec 2.6.41.</p> <p>4-Sec 2.7.7 added. disp_Sync(line) command added for uVGA-II(GFX) module.</p> <p>5-Updated SPI modes and SPI speeds. Note SPI diagram in Sec 2.10.1</p> <p>6-Fixed typing error in Sec 2.13.1 and 1.13.2. It's a 32 bit Timer.</p> <p>7-Fixed typing error in the Description in Sec 2.12.1.</p>	17/11/2011
4.0	<p>1-Removed predefined numbers from table 2.6.41. gfmt_Set should only be used with predefined names.</p> <p>2-Transparency, Contrast and Multiple Page Display/Read/Write details updated in Sec 2.6.41.</p> <p>3-Fixed typo in 2.4.10 strheight(pointer).</p> <p>4-Added Sec 2.3.11 CY().</p> <p>5-Added Sec 2.3.12 umul_1616(&res32, val1, val2)</p> <p>6-Added Sec 2.3.13 uadd_3232(&res32, &val1, &val2)</p> <p>7- Added Sec 2.3.14 usub_3232(&res32, &val1, &val2)</p> <p>8-Added Sec 2.3.15 ucmp_3232(&val1, &val2)</p> <p>9- Added Sec 2.16.18 str_ByteMove(src, dest, count)</p> <p>10-Added Sec 2.16.19 str_Copy(dest, src)</p> <p>11- Added Sec 2.16.20 str_CopyN(dest, src, count)</p>	17/02/2012
5.0	<p>1-Fixed typing error in the SWAP command. Sec 2.3.4</p> <p>2-Fixed typing errors in Sec 2.4.10</p> <p>3-Updated COM1 Default Baud rate details.</p> <p>4-Fixed typing error in Example. sys_EventsPostpone in Sec 2.13.7</p> <p>5-Added details to gfx_Cls() command Sec 2.6.1</p> <p>6-com_TXbuffer and com1_TXbuffer functions have been modified and take an extra parameter. It applies to PmmC R29 or above. Sec 2.11.11</p> <p>7-Description updated, Image control will now show error box for out of range video frames. If frame is set to -1, just a rectangle will be drawn in background colour to blank an image. It applies to PmmC R29 or above. Sec 2.18.6</p> <p>8-Description updated, Image control will now show error box for out of range video frames. Also, if frame is set to -1, just a rectangle will be drawn in background colour to blank an image. It applies to PmmC R29 or above. Sec 2.8.13</p>	08/06/2012
6.0	Reformatted, minor document updates	12/09/2012

Revision History Continued...

Revision	Revision Content	Revision Date
6.1	<p>Fixed minor TOC numbering issue</p> <p>1-It is now possible for a parent to access child globals when using file_LoadFunction. Sec 2.14.25 updated. Example added. Applies to PmmC R31 and above.</p> <p>2-sys_SetTimerEvent(timernum, function), description added. Sec 2.13.5.</p> <p>3-Sec 2.11.12, com_TXbufferHold(state) added.</p> <p>4-Sec 2.11.13, com_TXcount(), "Returns" part fixed.</p> <p>5-com_TXemptyEvent(...) description updated.</p> <p>com_TXemptyEvent(Function) is changed to com_TXemptyEvent(FunctionAddress). Added a better example in Sec 2.11.14 .</p>	23/11/2012
6.2	<p>Fixed minor issues in the wording and return types of some functions</p> <p>File_ScreenCapture – Typo in x and y description</p> <p>Gfx_Origin – Incorrect description</p> <p>Mem_Free – Return was incorrect</p> <p>Gfx_Get – Some modes were not listed, these have been added</p> <p>File_Image – Return was incorrect</p> <p>Media_Flush – Return was incorrect</p> <p>Sys_Sleep – Note added</p> <p>File_Exists – Removed wildcard support description, this was not supported</p> <p>File_Run, File_Exec – Status should be Value, otherwise OK</p> <p>PutW, putC – Return was incorrect</p> <p>SetBaud – Some % Errors listed in the SetBaud table were incorrect - Updated</p>	17/12/2012
6.3	<p>Fixes to str_Length() example</p> <p>Fixes to typo in mem_AllocV name, and description of size type and return improved</p> <p>Fixes to mem_Alloc size type and return improved</p> <p>Addition to type of Size in mem_Set command, and addition on an example</p> <p>Fixes to sys_SetTimerEvent() example, fix of typo</p> <p>Improvements made to img_SetWord and img_GetWord constant listings</p> <p>Improvement of img_SetImageControl description</p>	12/01/2013

9. Legal Notice

Proprietary Information

The information contained in this document is the property of 4D Systems Pty. Ltd. and may be the subject of patents pending or granted, and must not be copied or disclosed without prior written permission.

4D Systems endeavours to ensure that the information in this document is correct and fairly stated but does not accept liability for any error or omission. The development of 4D Systems products and services is continuous and published information may not be up to date. It is important to check the current position with 4D Systems. 4D Systems reserves the right to modify, update or make changes to Specifications or written material without prior notice at any time.

All trademarks belong to their respective owners and are recognised and acknowledged.

Disclaimer of Warranties & Limitation of Liability

4D Systems makes no warranty, either expressed or implied with respect to any product, and specifically disclaims all other warranties, including, without limitation, warranties for merchantability, non-infringement and fitness for any particular purpose.

Information contained in this publication regarding device applications and the like is provided only for your convenience and may be superseded by updates. It is your responsibility to ensure that your application meets with your specifications.

In no event shall 4D Systems be liable to the buyer or to any third party for any indirect, incidental, special, consequential, punitive or exemplary damages (including without limitation lost profits, lost savings, or loss of business opportunity) arising out of or relating to any product or service provided or to be provided by 4D Systems, or the use or inability to use the same, even if 4D Systems has been advised of the possibility of such damages.

4D Systems products are not fault tolerant nor designed, manufactured or intended for use or resale as on line control equipment in hazardous environments requiring fail – safe performance, such as in the operation of nuclear facilities, aircraft navigation or communication systems, air traffic control, direct life support machines or weapons systems in which the failure of the product could lead directly to death, personal injury or severe physical or environmental damage ('High Risk Activities'). 4D Systems and its suppliers specifically disclaim any expressed or implied warranty of fitness for High Risk Activities.

Use of 4D Systems' products and devices in 'High Risk Activities' and in any other application is entirely at the buyer's risk, and the buyer agrees to defend, indemnify and hold harmless 4D Systems from any and all damages, claims, suits, or expenses resulting from such use. No licenses are conveyed, implicitly or otherwise, under any 4D Systems intellectual property rights.

10. Contact Information

For Technical Support: support@4dsystems.com.au

For Sales Support: sales@4dsystems.com.au

Website: www.4dsystems.com.au

Copyright 4D Systems Pty. Ltd. 2000-2012.